



# Catálogo técnico









## Bica - BC30

 Ruta 34 Km 224 - Lote 81A Parque Industrial / Rafaela Santa Fe



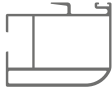

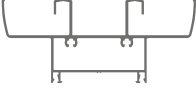

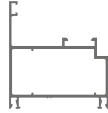
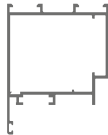
 03492-506001  [www.bicacolor.com.ar](http://www.bicacolor.com.ar)



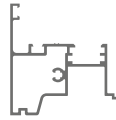

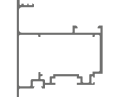
 @bica.color

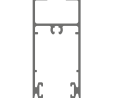
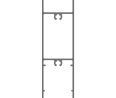
# ÍNDICE / Catálogo técnico Bica - BC30

| CÓDIGO           | DESCRIPCIÓN  | FORMA   | HOJA |
|------------------|--|---|------|
| <b>Cód. 5965</b> | Encuentro central corrediza de 4 hojas.<br>0,322 Kg/m - Largo 6,2 m. |    | 7    |
| <b>Cód. 5996</b> | Travesaño corrediza para vidrio simple.<br>1,030 Kg/m - Largo 6,2 m. |    | 7    |
| <b>Cód. 5997</b> | Travesaño corrediza para DVH.<br>0,970 Kg/m - Largo 6,2 m.           |    | 7    |
| <b>Cód. 3034</b> | Parante lateral corrediza.<br>1,390 Kg/m - Largo 6,2 m./4,80m.       |   | 8    |
| <b>Cód. 3035</b> | Parante central corrediza.<br>1,548 Kg/m - Largo 6,2 m./4,80m.       |  | 8    |
| <b>Cód. 3036</b> | Jambas de marco.<br>0,838 Kg/m - Largo 6,2 m./4,80m.                 |  | 8    |
| <b>Cód. 3037</b> | Umbral y dintel de marco.<br>1,806 Kg/m - Largo 6,2 m.               |  | 9    |
| <b>Cód. 3038</b> | Mosquitero reforzado.<br>0,612 Kg/m - Largo 6,2 m.                   |  | 9    |
| <b>Cód. 3039</b> | Tope mosquitero.<br>0,322 Kg/m - Largo 6,2m.                         |  | 9    |
| <b>Cód. 3040</b> | Marco puerta de rebatir.<br>1,419 Kg/m - Largo 6,2m.                 |  | 10   |
| <b>Cód. 3041</b> | Hoja puerta de rebatir.<br>1,193 Kg/m - Largo 6,2m.                  |  | 10   |

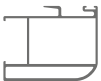
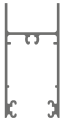
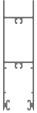
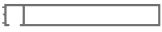
| CÓDIGO           | DESCRIPCIÓN   | FORMA   | HOJA |
|------------------|---|---|------|
| <b>Cód. 3042</b> | Travesaño puerta de rebatir.<br>1,354 Kg/m - Largo 6,2 m.                     |    | 11   |
| <b>Cód. 3043</b> | Zócalo puerta de rebatir.<br>2,387 Kg/m - Largo 6,2 m.                        |    | 11   |
| <b>Cód. 3044</b> | Encuentro central puerta de rebatir.<br>0,935 Kg/m - Largo 6,2 m.             |    | 12   |
| <b>Cód. 3045</b> | Contravidrio recto para vidrio simple.<br>0,354 Kg/m - Largo 6,2 m.           |   | 12   |
| <b>Cód. 3046</b> | Contravidrio recto para DVH.<br>0,258 Kg/m - Largo 6,2 m.                     |  | 12   |
| <b>Cód. 3047</b> | Contravidrio curvo para vidrio simple.<br>0,258 Kg/m - Largo 6,2 m.           |  | 12   |
| <b>Cód. 3048</b> | Contravidrio curvo para DVH.<br>0,225 Kg/m - Largo 6,2 m.                     |  | 13   |
| <b>Cód. 3049</b> | Contravidrio recto lado exterior puerta de rebatir. 0,258 Kg/m - Largo 6,2 m. |  | 13   |
| <b>Cód. 3050</b> | Contravidrio curvo lado exterior puerta de rebatir. 0,225 Kg/m - Largo 6,2 m. |  | 13   |
| <b>Cód. 3051</b> | Marcos ventana de abrir.<br>1,005 Kg/m - Largo 6,2 m.                         |  | 13   |
| <b>Cód. 3052</b> | Hoja curva ventana de abrir.<br>1,225 Kg/m - Largo 6,2 m.                     |  | 14   |

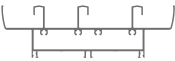
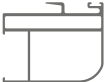
| CÓDIGO           | DESCRIPCIÓN   | FORMA   | HOJA |
|------------------|---|---|------|
| <b>Cód. 3053</b> | Encuentro central ventana de abrir.<br>1,032 Kg/m - Largo 6,2 m.    |    | 14   |
| <b>Cód. 3054</b> | Hoja recta ventana de abrir.<br>1,193 Kg/m - Largo 6,2 m.           |    | 14   |
| <b>Cód. 3055</b> | Marco paño fijo y ventana de abrir.<br>0,967 Kg/m - Largo 6,2 m.    |    | 15   |
| <b>Cód. 3057</b> | Marco ventana desplazable.<br>0,870 Kg/m - Largo 6,2 m.             |   | 15   |
| <b>Cód. 3058</b> | Hoja recta ventana desplazable.<br>1,387 Kg/m - Largo 6,2 m.        |  | 16   |
| <b>Cód. 3059</b> | Marco recto paño fijo y ventana de abrir. 1,258 Kg/m - Largo 6,2 m. |  | 16   |
| <b>Cód. 3066</b> | Premarco.<br>0,548 Kg/m - Largo 6,2 m.                              |  | 16   |
| <b>Cód. 3061</b> | Zócalo y cabezal ventana corrediza.<br>0,903 Kg/m - Largo 6,2 m.    |  | 17   |
| <b>Cód. 3062</b> | Zócalo alto puerta corrediza.<br>1,387 Kg/m - Largo 6,2m.           |  | 17   |
| <b>Cód. 3067</b> | Perfiles de acople.<br>0,322 Kg/m - Largo 6,2m.                     |  | 18   |
| <b>Cód. 3069</b> | Acople a 90°.<br>1,005 Kg/m - Largo 6,2m.                           |  | 18   |

| CÓDIGO           | DESCRIPCIÓN   | FORMA   | HOJA |
|------------------|---|---|------|
| <b>Cód. 3071</b> | Parante lateral corrediza para DVH.<br>1,322 Kg/m - Largo 6,2 m./4,80m. |    | 19   |
| <b>Cód. 3072</b> | Parante central corrediza para DVH.<br>1,451 Kg/m - Largo 6,2 m./4,80m. |    | 19   |
| <b>Cód. 3073</b> | Zócalo y cabezal corrediza para DVH.<br>0,838 Kg/m - Largo 6,2 m.       |    | 20   |
| <b>Cód. 3074</b> | Zócalo alto corrediza para DVH.<br>1,354 Kg/m - Largo 6,2 m.            |   | 20   |
| <b>Cód. 3079</b> | Premarco corrediza de 3 hojas.<br>0,935 Kg/m - Largo 6,2 m.             |  | 21   |
| <b>Cód. 3080</b> | Jamba de marco corrediza de 3 hojas.<br>1,645 Kg/m - Largo 6,2 m.       |  | 21   |
| <b>Cód. 3081</b> | Umbral y dintel corrediza de 3 hojas.<br>2,774 Kg/m - Largo 6,2 m.      |  | 22   |
| <b>Cód. 3082</b> | Parante central tercera hoja para DVH.<br>1,419 Kg/m - Largo 6,2 m.     |  | 23   |
| <b>Cód. 3083</b> | Parante central tercera hoja.<br>1,516 Kg/m - Largo 6,2 m.              |  | 23   |

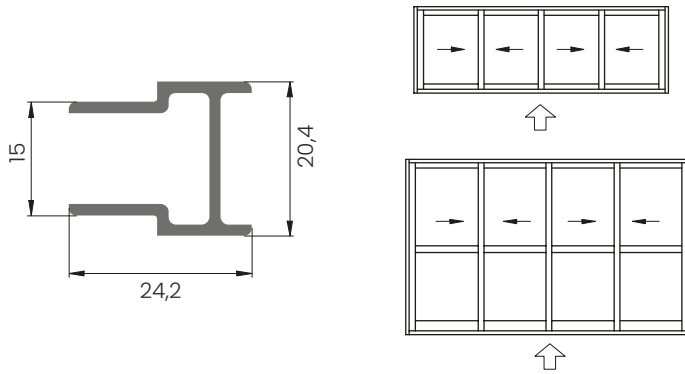

**Cód. 5965**

Encuentro central corrediza de 4 hojas.  
0,322 Kg/m - Largo 6,2 m.

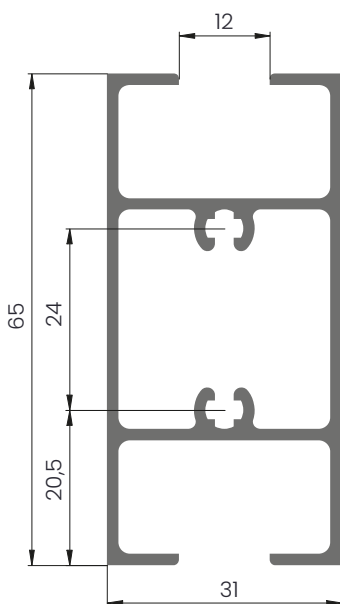

**Cód. 5996**

Travesaño corrediza para vidrio simple.  
1,030 Kg/m - Largo 6,2 m.

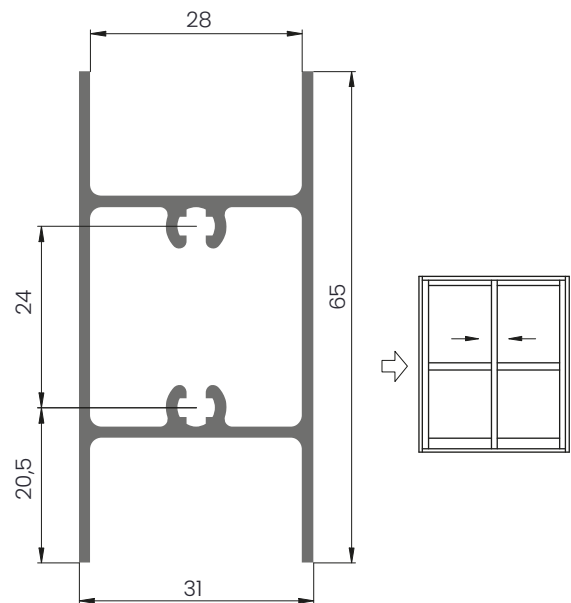

**Cód. 5997**

Travesaño corrediza para DVH.  
0,970 Kg/m - Largo 6,2 m.

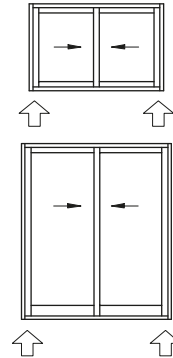
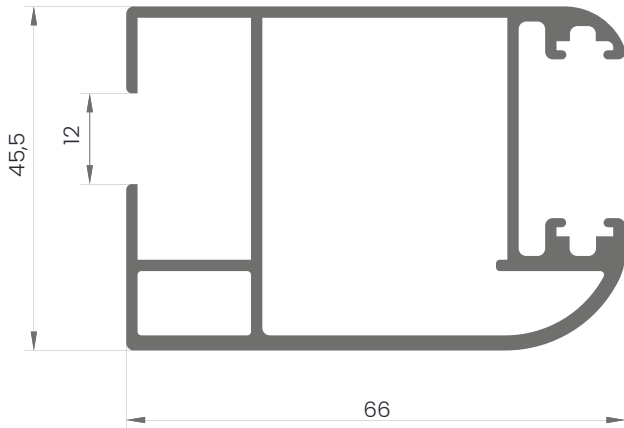

**Cód. 3034**

Parante lateral corrediza.  
1,390 Kg/m - Largo 6,2 m.

-opcional largo 4,80 m. -

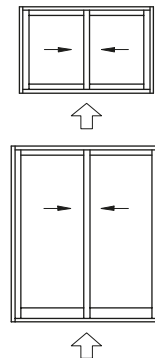
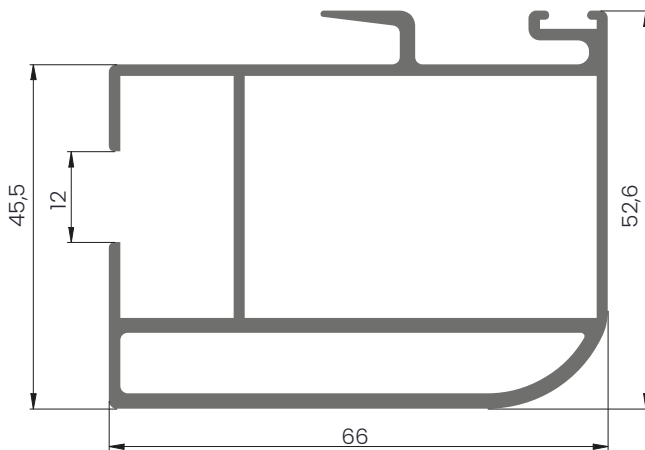

**Cód. 3035**

Parante central corrediza.  
1,548 Kg/m - Largo 6,2 m.

-opcional largo 4,80 m. -

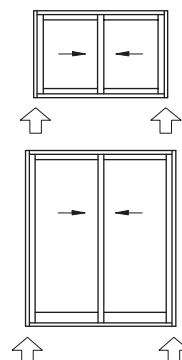
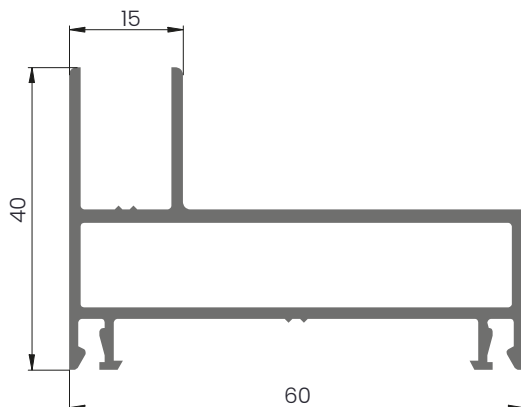

**Cód. 3036**

Jambas de marco.  
0,838 Kg/m - Largo 6,2 m.

-opcional largo 4,80 m. -



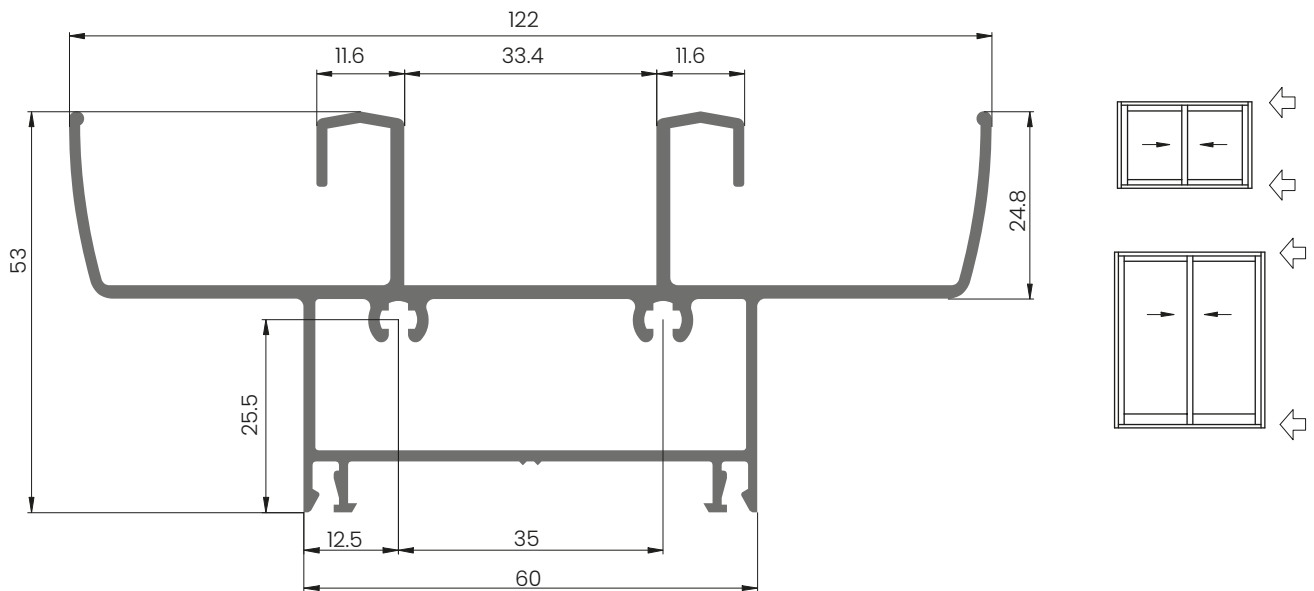

### Cód. 3037

Umbral y dintel de marco.  
1,806 Kg/m - Largo 6,2 m.

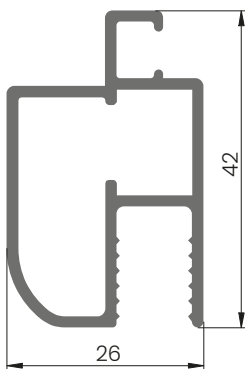

### Cód. 3038

Mosquitero reforzado.  
0,612 Kg/m - Largo 6,2 m.



### Cód. 3039

Tope mosquitero.  
0,8322 Kg/m - Largo 6,2 m.

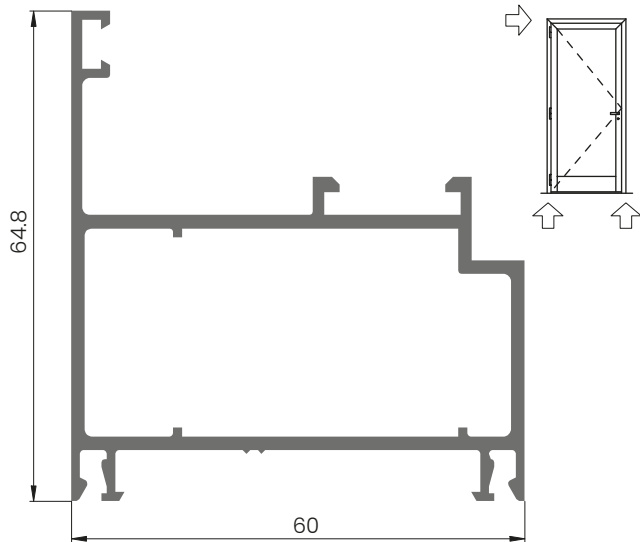

**Cód. 3040**

Marco puerta de rebatir.  
1,419 Kg/m - Largo 6,2 m.

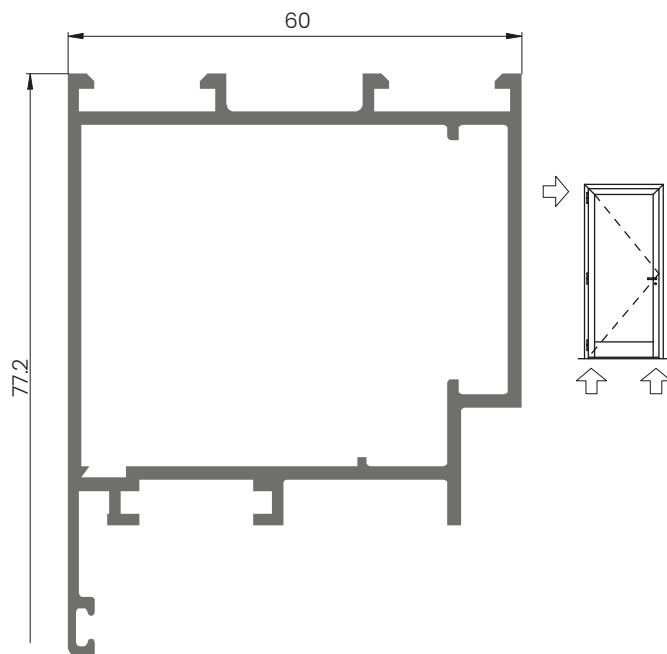

**Cód. 3041**

Hoja puerta de rebatir.  
1,193 Kg/m - Largo 6,2 m.

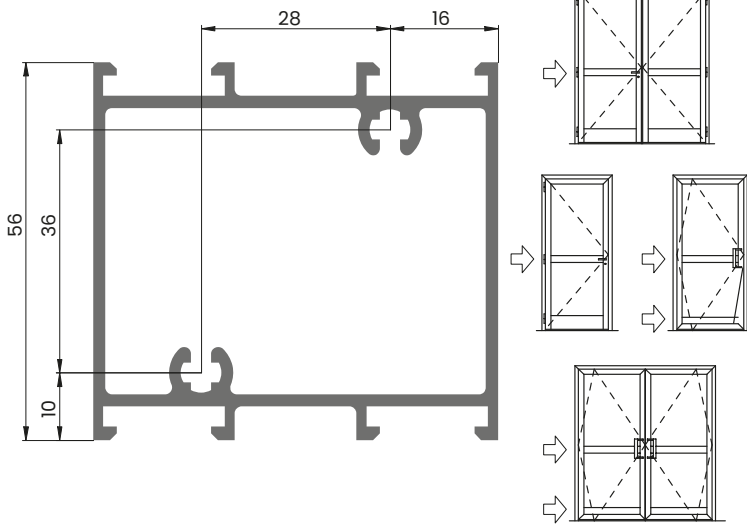

**Cód. 3042**

Travesaño puerta de rebatir.  
1,354 Kg/m - Largo 6,2 m.

**Cód. 3043**

Zócalo puerta de rebatir.  
2,387 Kg/m - Largo 6,2 m.

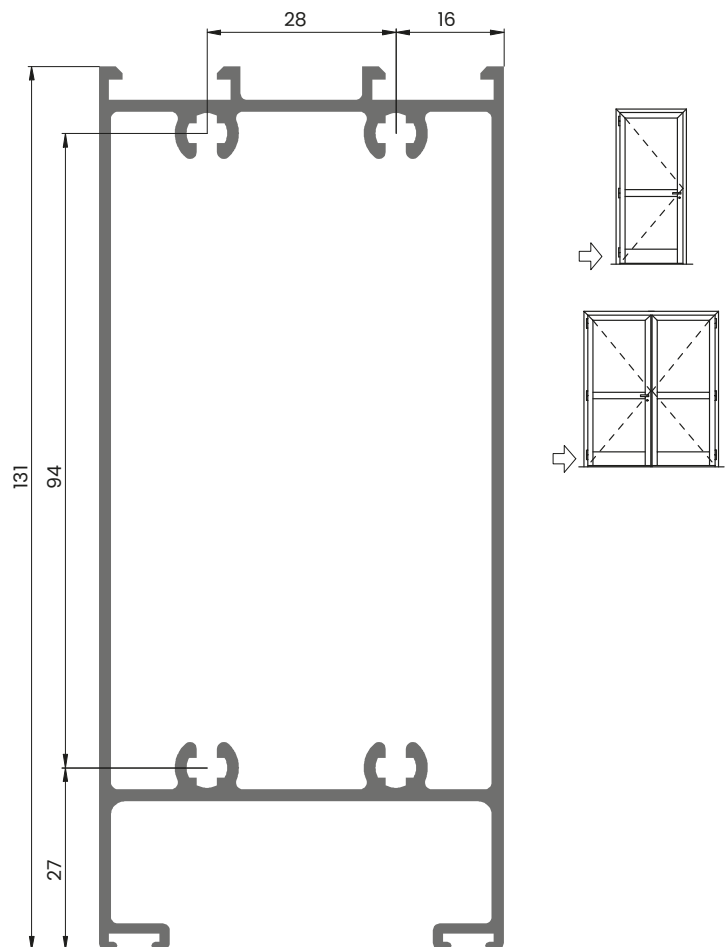

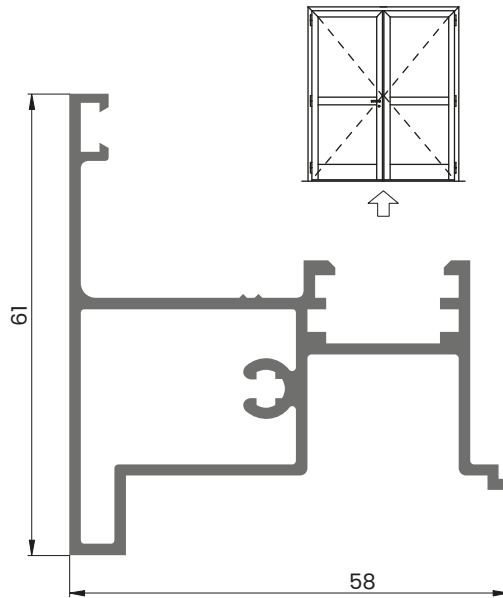

**Cód. 3044**

Encuentro central puerta de rebatir.  
0,935 Kg/m - Largo 6,2 m.

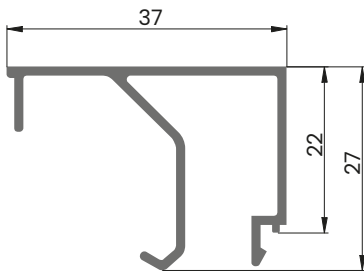

**Cód. 3045**

Contravidrio recto  
para vidrio simple.  
0,354 Kg/m - Largo 6,2 m.

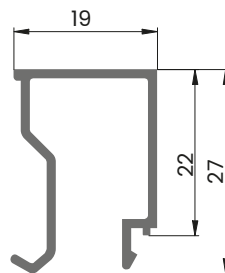

**Cód. 3046**

Contravidrio recto para DVH.  
0,3258 Kg/m - Largo 6,2 m.

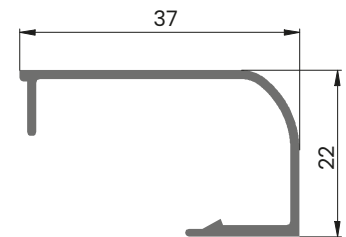

**Cód. 3047**

Contravidrio curvo  
para vidrio simple.  
0,258 Kg/m - Largo 6,2 m.

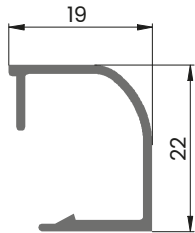

**Cód.3048**

Contravidrio curvo para DVH.  
0,225 Kg/m - Largo 6,2 m.

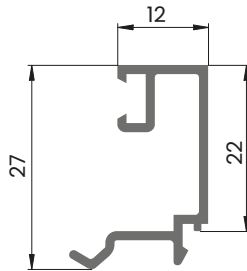

**Cód. 3049**

Contravidrio recto lado exterior puerta de rebatir.  
0,258 Kg/m - Largo 6,2 m.

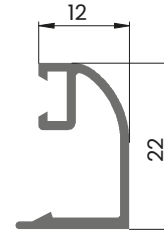

**Cód. 3050**

Contravidrio curvo lado exterior puerta de rebatir.  
0,225 Kg/m - Largo 6,2 m.

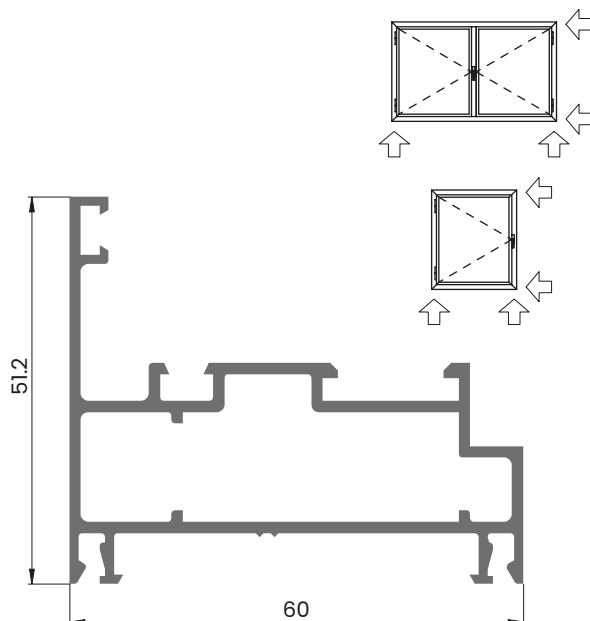

**Cód. 3051**

Marco ventana de abrir.  
1,005 Kg/m - Largo 6,2 m.

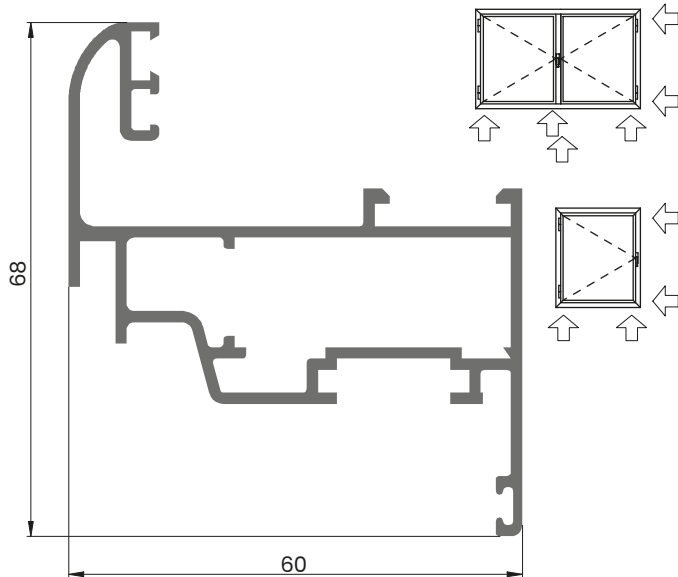

**Cód.3052**

Hoja curva ventana de abrir.  
1,225 Kg/m - Largo 6,2 m.

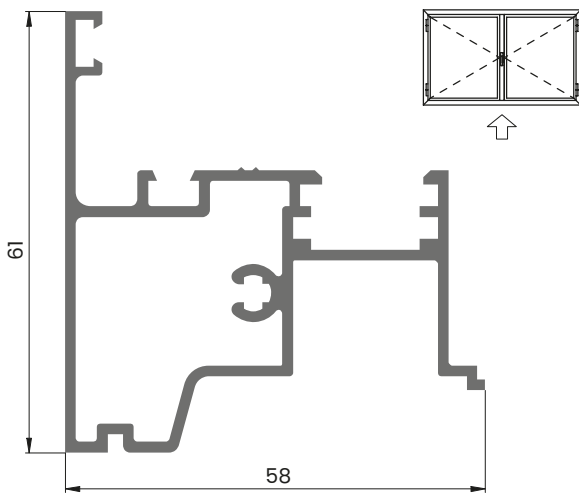

**Cód.3053**

Encuentro central ventana de abrir.  
1,032 Kg/m - Largo 6,2 m.

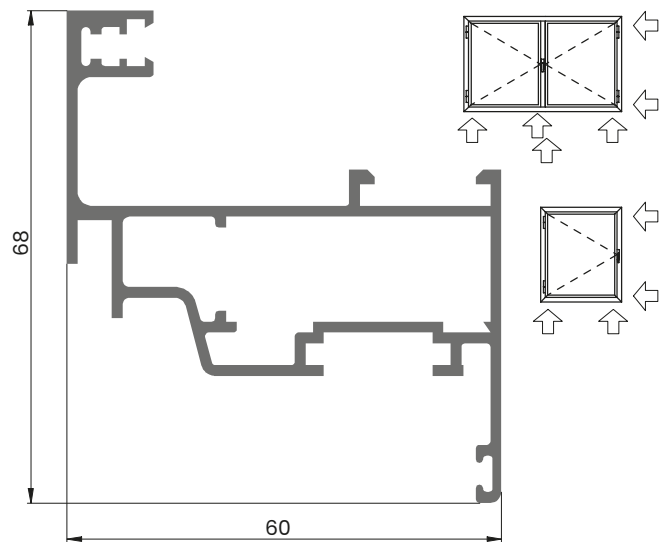

**Cód.3054**

Hoja recta ventana de abrir.  
1,193 Kg/m - Largo 6,2 m.

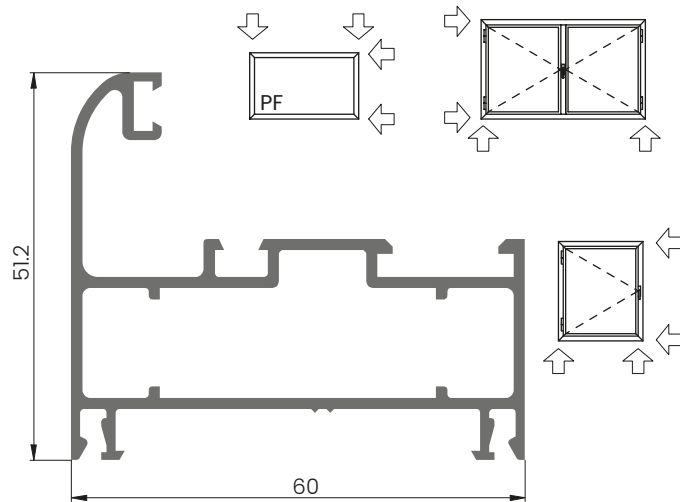

**Cód.3055**

Marco paño fijo  
y ventana de abrir.  
0,967 Kg/m - Largo 6,2 m.

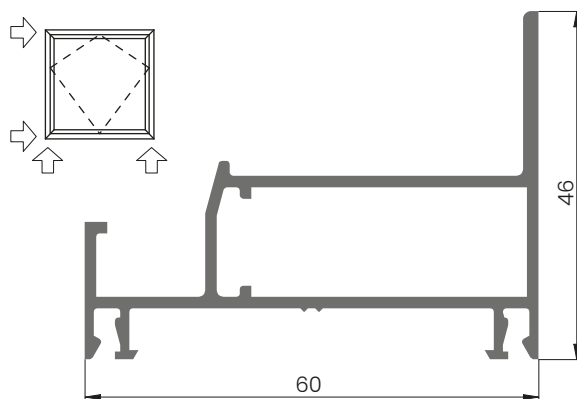

**Cód.3057**

Marco ventana desplazable.  
0,870 Kg/m - Largo 6,2 m.

**Cód.3058**

Hoja recta ventana desplazable.  
1,387 Kg/m - Largo 6,2 m.

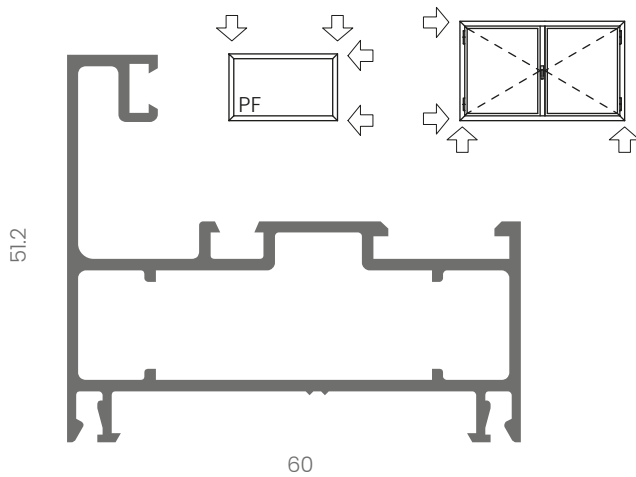
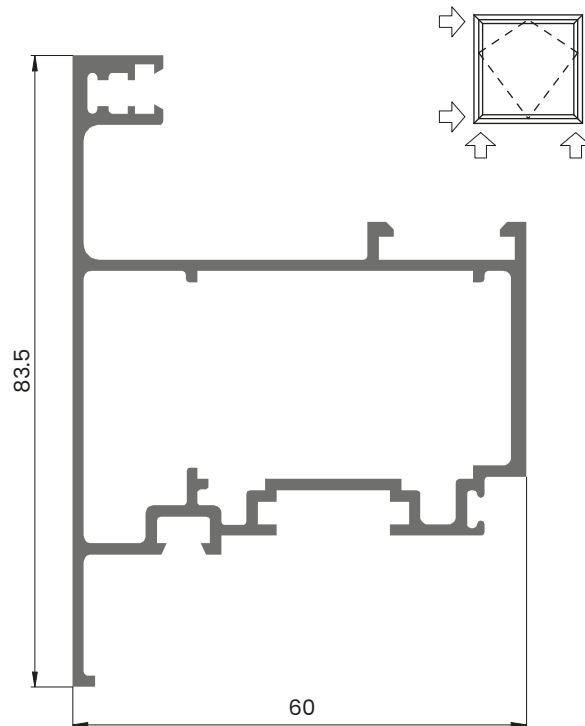

**Cód.3059**

Marco recto paño fijo y ventana de abrir.  
1,258 Kg/m - Largo 6,2 m.

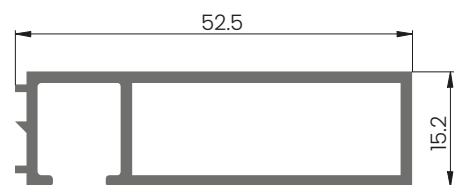

**Cód.3066**

Premarco.  
0,548 Kg/m - Largo 6,2 m.



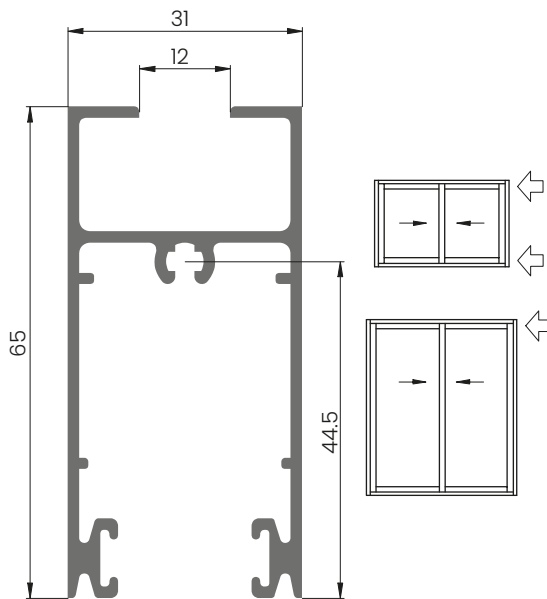

**Cód. 3061**

Zócalo y cabezal ventana corrediza.  
0,903 Kg/m - Largo 6,2 m.

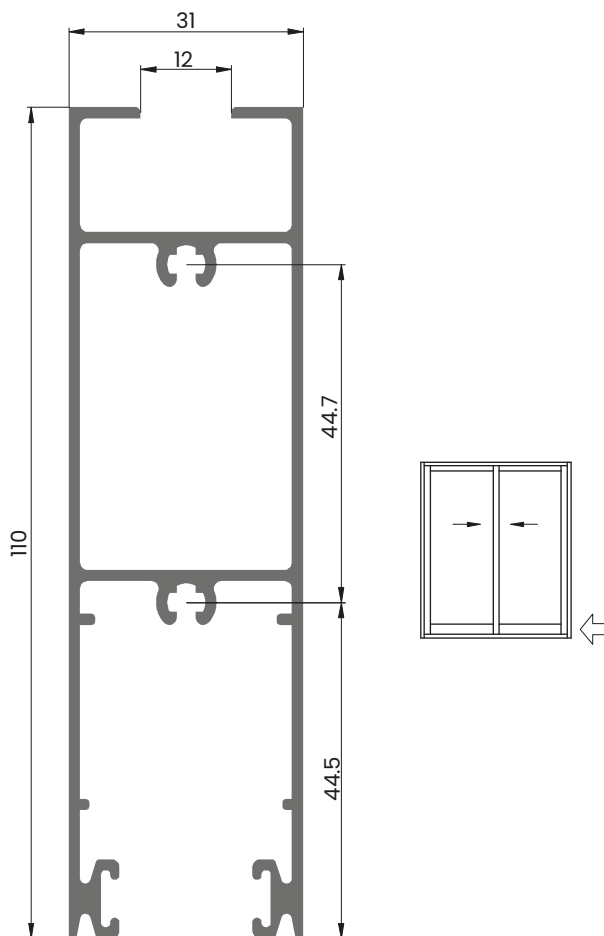

**Cód. 3062**

Zócalo alto puerta corrediza.  
1,387 Kg/m - Largo 6,2 m.

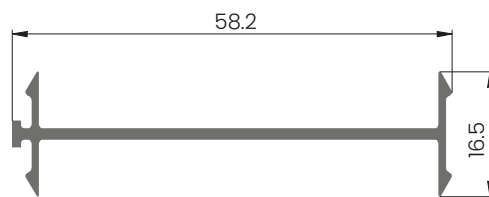

**Cód. 3067**

Perfiles de acople.  
0,322 Kg/m - Largo 6,2 m.

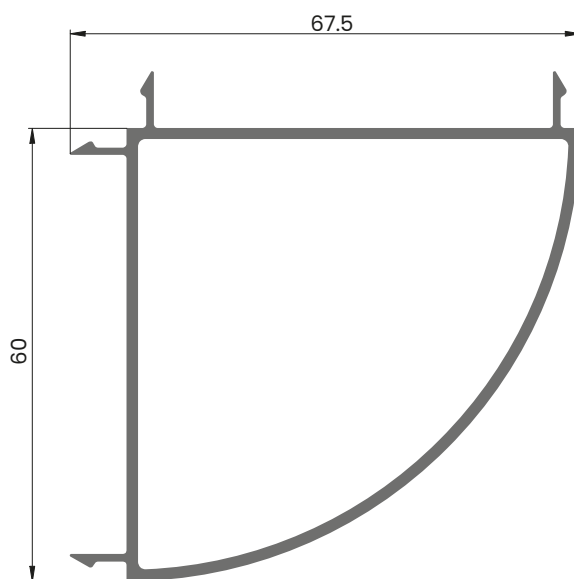

**Cód. 3069**

Acople a 90°.  
1,005 Kg/m - Largo 6,2 m.

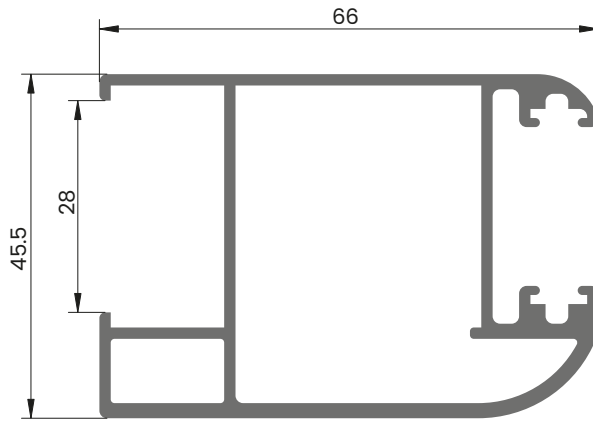

**Cód. 3071**

Parante lateral  
corrediza para DVH.  
1,322 Kg/m - Largo 6,2 m.

-opcional largo 4,80 m. -

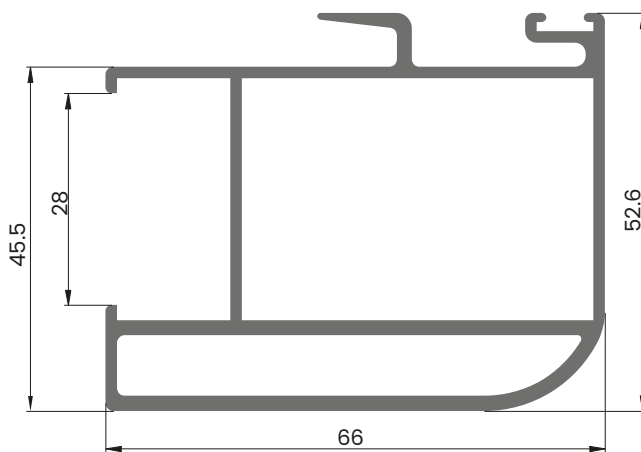
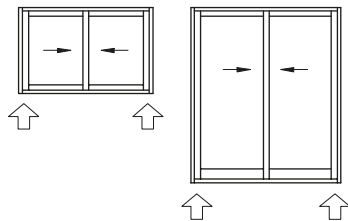

**Cód. 3072**

Parante central  
corrediza para DVH.  
1,451 Kg/m - Largo 6,2 m.

-opcional largo 4,80 m. -

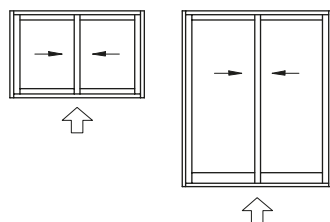

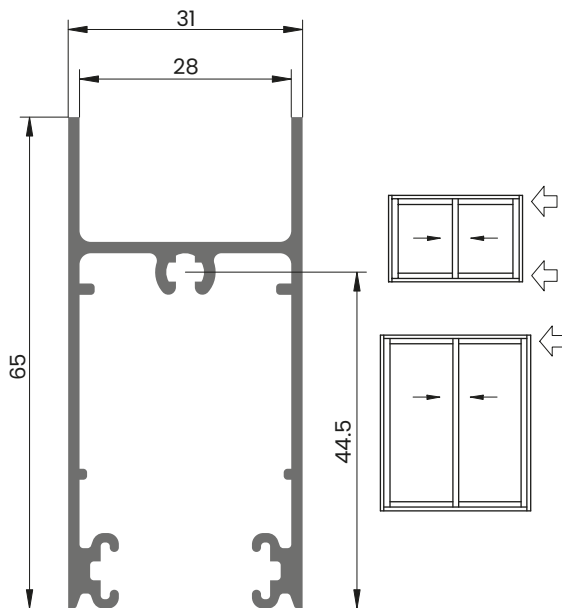

**Cód. 3073**

Zócalo y cabezal  
corrediza para DVH.  
0,838 Kg/m - Largo 6,2 m.

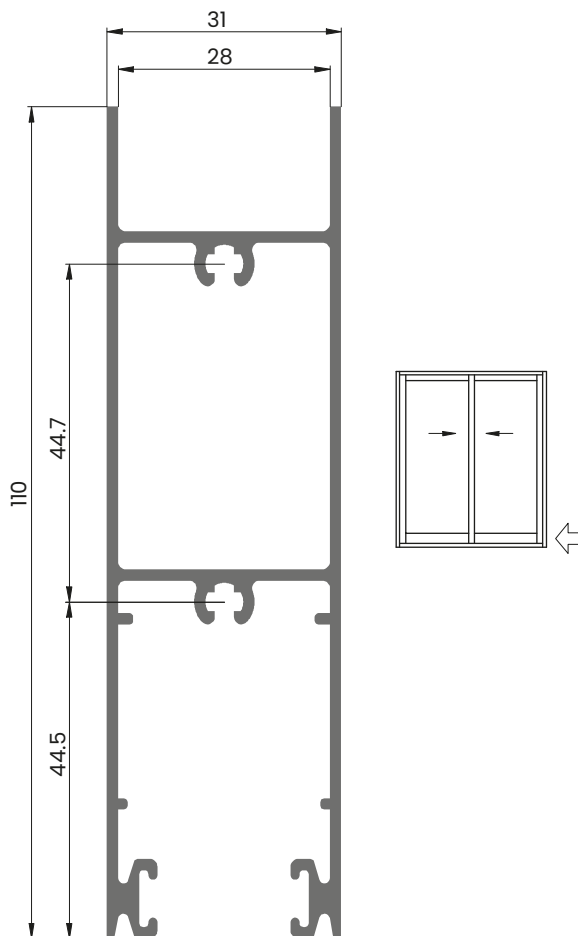

**Cód. 3074**

Zócalo alto  
corrediza para DVH.  
1,354 Kg/m - Largo 6,2 m.

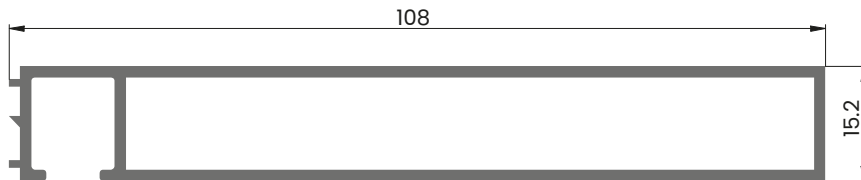

### Cód. 3079

Premarco corrediza de 3 hojas.  
0,935 Kg/m - Largo 6,2 m.

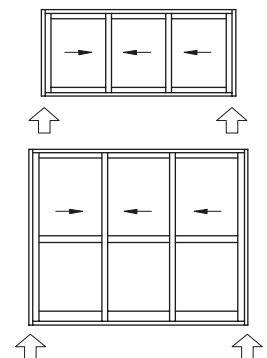
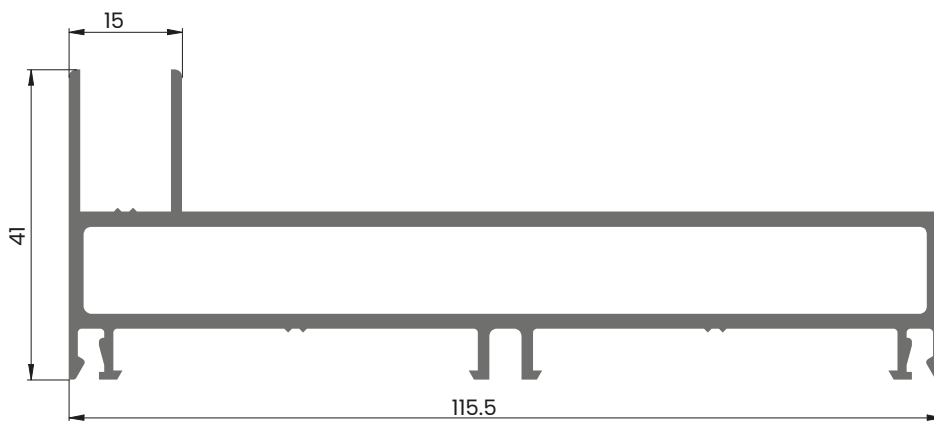

### Cód. 3080

Jambas de marco corrediza de 3 hojas.  
1,645 Kg/m - Largo 6,2 m.

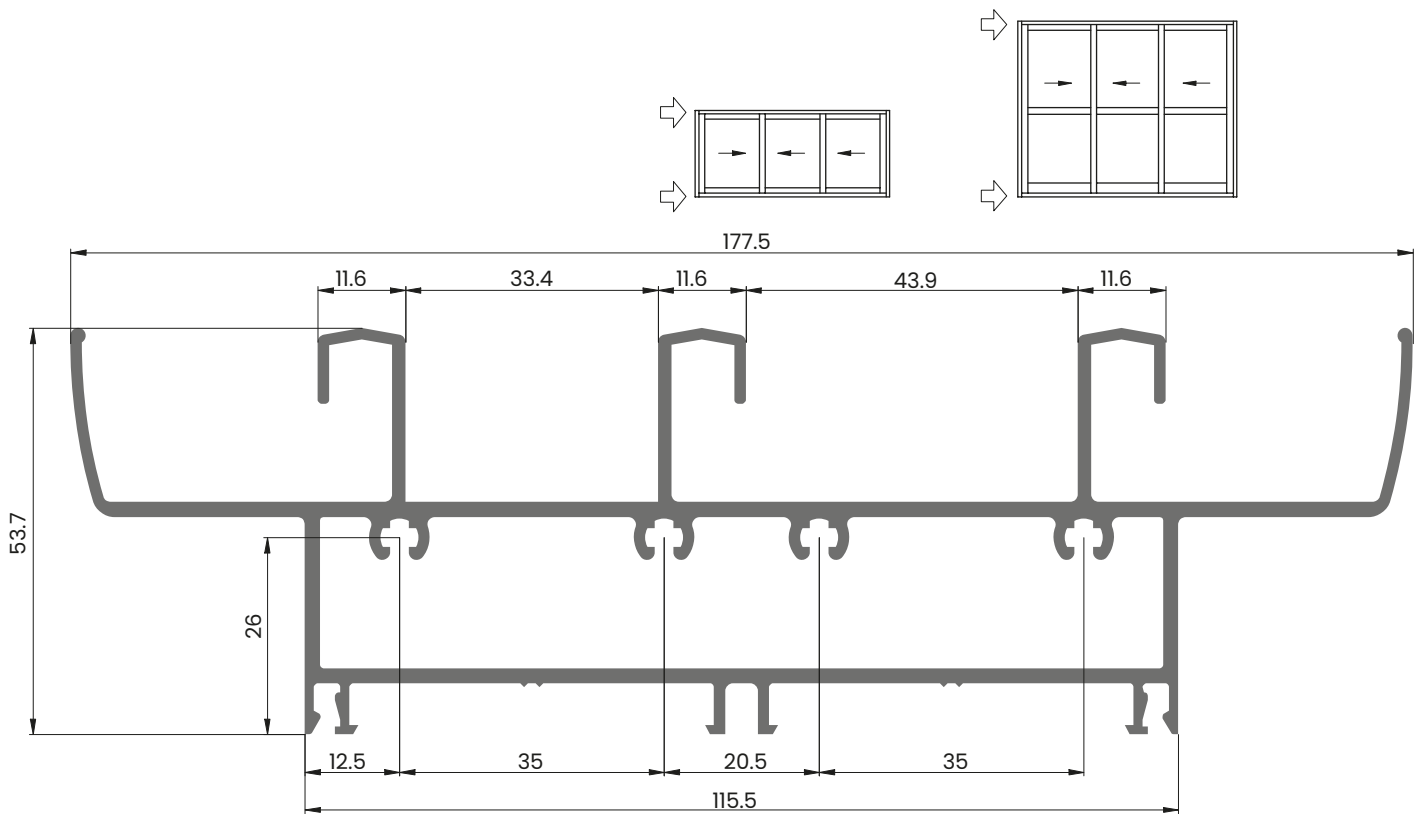

## Cód. 3081

Umbral y dintel corrediza de 3 hojas.  
2,774 Kg/m - Largo 6,2 m.

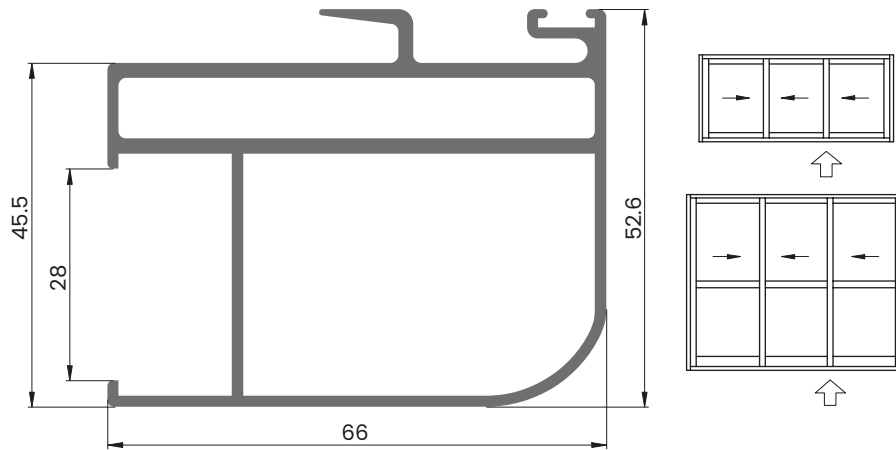

**Cód. 3082**

Parante central tercera hoja para DVH.  
1,419 Kg/m - Largo 6,2 m.

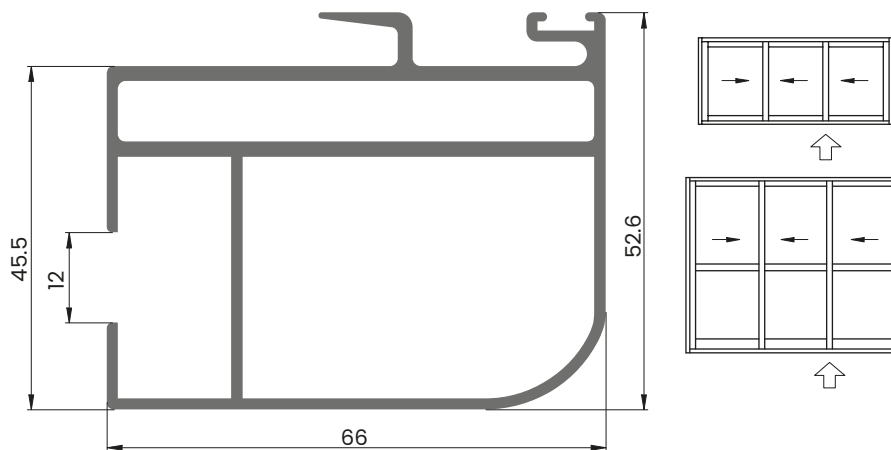

**Cód. 3083**

Parante central tercera hoja.  
1,516 Kg/m - Largo 6,2 m.



📍 Ruta 34 Km 224 - Lote 81A Parque Industrial / Rafaela Santa Fe

📞 03492-506001 🌐 [www.bicacolor.com.ar](http://www.bicacolor.com.ar)

📷 @bica.color