



Catálogo técnico Perfiles Línea Modena







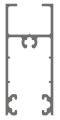
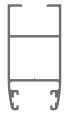
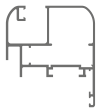
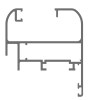
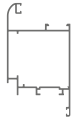

📍 Ruta 34 Km 224 - Lote 81A Parque Industrial / Rafaela Santa Fe

📞 03492-506001 🌐 www.bicacolor.com.ar

📷 @bica.color

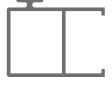
ÍNDICE / Línea Modena

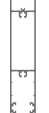
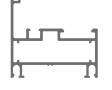









CÓDIGO	DESCRIPCIÓN	FORMA	HOJA
Cód. 1200	Umbral y dintel de marco corrediza. 1,322 Kg/m - Largo 6,2 m.		10
Cód. 1201	Jambas de marco corrediza. 0,645 Kg/m - Largo 6,2 m.		10
Cód. 1202	Zócalo y cabezal de hoja VS. 0,709 Kg/m - Largo 6,2 m.		10
Cód. 1203	Parante lateral VS. 0,645 Kg/m - Largo 6,2 m.		11
Cód. 1204	Parante central hoja para VS. 0,550 Kg/m - Largo 6,2 m.		11
Cód. 2216	Marco venta de abrir / Banderola / Puerta / Paño fijo. 0,741 Kg/m - Largo 6,2 m.		28
Cód. 2235	Hoja ventana abrir vidrio simple. 1,045 Kg/m - Largo 6,2 m.		28
Cód. 2236	Hoja ventana abrir DVH. 1,015 Kg/m - Largo 6,2 m.		28
Cód. 2273	Parante puerta de rebatir con contravidrio curvo. 1,15 Kg/m - Largo 6,2m.		32
Cód. 2274	Travesaño de puerta de 50mm. 1,080 Kg/m - Largo 6,2m.		31
Cód. 2275	Zócalo de puerta de 50mm. 1,716 Kg/m - Largo 6,2m.		31

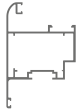



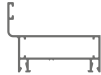



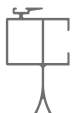

CÓDIGO	DESCRIPCIÓN	FORMA	HOJA
Cód. 3010	Escuadra de armado reforzado. 0,990 Kg/m - Largo 6m.		30
Cód. 3067	Escuadra suplementaria puerta de rebatir. 1,050 Kg/m - Largo 6m.		30
Cód. 3202	Zócalo para DVH. 0,655 Kg/m - Largo 6,2 m.		19
Cód. 3203	Parante lateral corrediza para DVH. 0,645 Kg/m - Largo 6,2 m.		19
Cód. 3204	Parante central corrediza para DVH. 0,638 Kg/m - Largo 6,2 m.		19
Cód. 3205	Premarco. 0,355 Kg/m - Largo 6,2 m.		11
Cód. 3206	Tapa premarco. 0,201 Kg/m - Largo 6,2 m.		11
Cód. 3209	Zócalo alto vidrio simple. 1,355 Kg/m - Largo 6,2 m.		12
Cód. 3210	Marco de abrir con cámara compensadora. 0,838 Kg/m - Largo 6,2 m.		12
Cód. 3212	Contravidrio recto 36mm. 0,354 Kg/m - Largo 6,2 m.		16
Cód. 3213	Perfil de acople. 0,29 Kg/m - Largo 6,2 m.		12

CÓDIGO	DESCRIPCIÓN	FORMA	HOJA
Cód. 3214	Jambas y cabezal hoja puerta de rebatir. 1,208 Kg/m - Largo 6,2 m.		12
Cód. 3215	Hoja ventana de abrir doble contact banderola. 0,995 Kg/m - Largo 6,2 m.		14
Cód. 3216	Marco de rebatir. 0,71 Kg/m - Largo 6,2 m.		13
Cód. 3217	Contravidrio recto 29mm. 0,291 Kg/m - Largo 6,2 m.		16
Cód. 3218	Travesaño hoja puerta de rebatir. 1,193 Kg/m - Largo 6,2 m.		14
Cód. 3219	Zócalo hoja puerta de rebatir. 1,645 Kg/m - Largo 6,2 m.		14
Cód. 3220	Contravidrio exterior puerta de rebatir. 0,193 Kg/m - Largo 6,2 m.		13
Cód. 3221	Travesaño angosto paño fijo. 0,760 Kg/m - Largo 6,2 m.		15
Cód. 3222	Travesaño angosto modena. 0,819 Kg/m - Largo 6,2 m.		29
Cód. 3223	Encuentro central ventana de abrir con cámara compensadora. 0,975 Kg/m - Largo 6,2 m.		16
Cód. 3224	Encuentro central ventana de abrir doble contacto. 0,806 Kg/m - Largo 6,2 m.		16

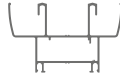
CÓDIGO	DESCRIPCIÓN	FORMA	HOJA
Cód. 3225	Contravidrio recto de 22mm. 0,258 Kg/m - Largo 6,2 m.		16
Cód. 3226	Contravidrio recto de 15mm. 0,233 Kg/m - Largo 6,2 m.		16
Cód. 3227	Hoja ventiluz. 0,840 Kg/m - Largo 6,2 m.		15
Cód. 3228	Tope mosquitero corrediza. 0,201 Kg/m - Largo 6,2 m.		17
Cód. 3229	Marco paño fijo curvo. 0,741 Kg/m - Largo 6,2 m.		17
Cód. 3230	Contravidrio curvo 29mm. 0,225 Kg/m - Largo 6,2 m.		17
Cód. 3231	Contravidrio curvo 15mm. 0,165 Kg/m - Largo 6,2 m.		17
Cód. 3232	Contravidrio curvo 22mm. 0,201 Kg/m - Largo 6,2 m.		17
Cód. 3233	Contravidrio curvo 8mm. 0,199 Kg/m - Largo 6,2 m.		17
Cód. 3234	Hoja ventana de abrir con cámara compensadora. 0,880 Kg/m - Largo 6,2 m.		15
Cód. 3235	Hoja de abrir doble contacto. 0,885 Kg/m - Largo 6,2 m.		18

CÓDIGO	DESCRIPCIÓN	FORMA	HOJA
Cód. 3236	Hoja curva ventiluz. 0,897 Kg/m - Largo 6,2 m.		18
Cód. 3237	Contravidrio puerta de rebatir. 0,139 Kg/m - Largo 6,2 m.		13
Cód. 3238	Contravidrio curvo 36mm. 0,201 Kg/m - Largo 6,2 m.		17
Cód. 3239	Travesaño para hoja corrediza vidrio simple. 0,755 Kg/m - Largo 6,2 m.		24
Cód. 3240	Marco de 3 guías corte 45°. 1,87 Kg/m - Largo 6,2 m.		18
Cód. 3241	Jamba de marco de 3 guías. 0,995 Kg/m - Largo 6,2 m.		19
Cód. 3243	Guía de cortina común. 0,615 Kg/m - Largo 6m.		27
Cód. 3244	Guía de cortina. 0,766 Kg/m - Largo 6,2 m.		27
Cód. 3246	Encuentro central de 4 hojas V y P corrediza. 0,322 Kg/m - Largo 6,2 m.		22
Cód. 3252	Zócalo ato corrediza para DVH. 1,258 Kg/m - Largo 6,2 m.		20
Cód. 3253	Travesaño para hoja corredeiza DVH. 0,695 Kg/m - Largo 6,2 m.		20

CÓDIGO	DESCRIPCIÓN	FORMA	HOJA
Cód. 3255	Bastidor mosquitero. 0,451 Kg/m - Largo 6,2 m.		20
Cód. 3256	Travesaño mosquitero. 0,548 Kg/m - Largo 6,2 m.		21
Cód. 3259	Marco de ventana proyectante recta. 0,741 Kg/m - Largo 6,2 m.		21
Cód. 3260	Hoja de ventana proyectante curva. 1,161 Kg/m - Largo 6,2 m.		21
Cód. 3261	Columna de acople reforzado. 1,305 Kg/m - Largo 6,2 m.		24
Cód. 3262	Acople a 90°. 0,685 Kg/m - Largo 6,2 m.		22
Cód. 3263	Columna 45° MD. 0,615 Kg/m - Largo 6m.		27
Cód. 3264	Marco puerta placa. 0,596 Kg/m - Largo 6,2m.		32
Cód. 3266	Marco vidrio repartido para ventana y paño fijo. 0,315 Kg/m - Largo 6m.		25
Cód. 3267	Trav. vidrio repartido para ventana y puerta corrediza. 0,409 Kg/m - Largo 6m.		25
Cód. 3268	Trav. vidrio repartido para ventana y puerta corrediza. 0,409 Kg/m - Largo 6m.		25

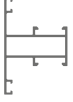
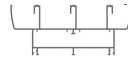
CÓDIGO	DESCRIPCIÓN	FORMA	HOJA
Cód. 3280	Parante central con tirador hoja VS. 0,99 Kg/m - Largo 6,2 m.		13
Cód. 3449	Grapa de amure para premarco. 0,250 Kg/m - Largo 6m.		30
Cód. 3901	Premarco 73mm. 0,710 Kg/m - Largo 6,2m.		26
Cód. 3905	Complemento parante central con tirador. 0,677 Kg/m - Largo 6m.		30
Cód. 3906	Marco prerimetral corrediza 45°. 1,185 Kg/m - Largo 6,2 m.		22
Cód. 3907	Complemento parante central corrediza 45°. 0,345 Kg/m - Largo 6,2 m..		23
Cód. 3908	Hoja de vidrio simple corrediza 45°. 0,875 Kg/m - Largo 6,2 m.		23
Cód. 3909	Hoja DVH corrediza 45°. 0,820 Kg/m - Largo 6,2 m.		23
Cód. 3912	Premarco 51mm. 0,546 Kg/m - Largo 6,2m.		26
Cód. 4118	Tapa premarco. 0,345 Kg/m - Largo 6,2 m.		21
Cód. 6257	Travesaño curvo. 0,806 Kg/m - Largo 6,2 m.		29
Cód. 6910	Guía triple corrediza 45°. 1,625 Kg/m - Largo 6,2 m.		23

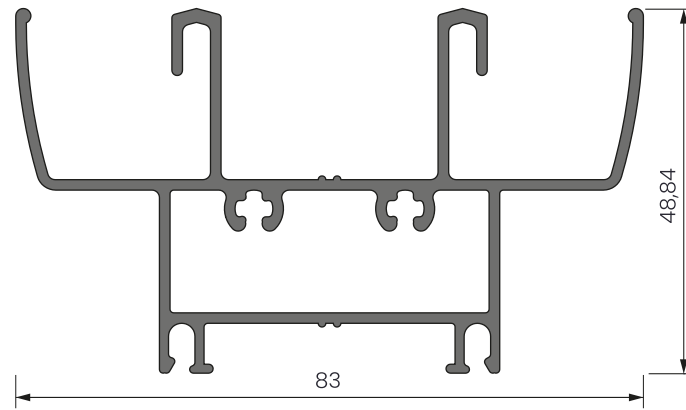

Cód. 1200

Umbral y dintel de marco corrediza.
1,322 Kg/m - Largo 6,2 m.

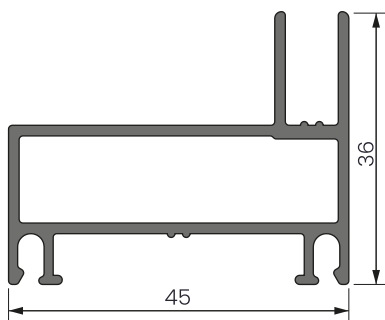

Cód. 1201

Jambas de marco corrediza.
0,645 Kg/m - Largo 6,2 m.

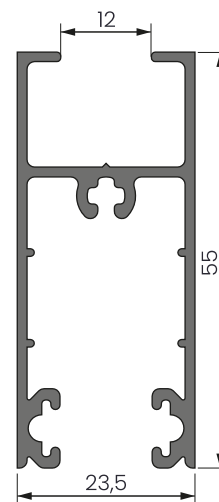

Cód. 1202

Zócalo y cabezal de hoja VS.
0,709 Kg/m - Largo 6,2 m.

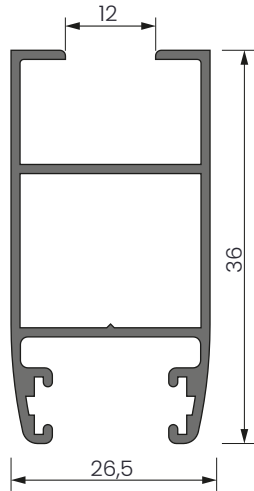

Cód. 1203

Parante lateral VS.
0,645 Kg/m - Largo 6,2 m.

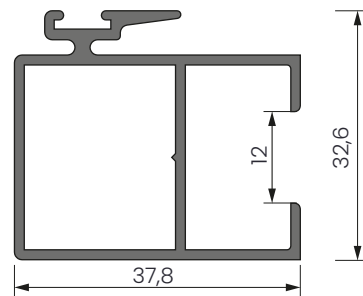

Cód. 1204

Parante central hoja para VS.
0,550 Kg/m - Largo 6,2 m.

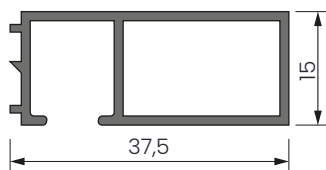

Cód. 3205

Premarco.
0,355 Kg/m - Largo 6,2 m.

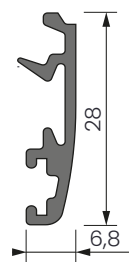

Cód. 3206

Tapa premarco.
0,201 Kg/m - Largo 6,2 m.

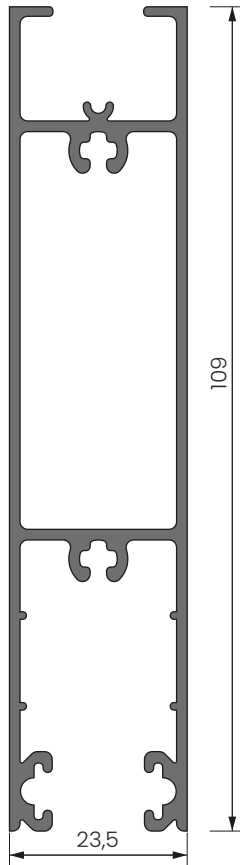

Cód. 3209

Zócalo alto vidrio simple.
1,355 Kg/m - Largo 6,2 m.

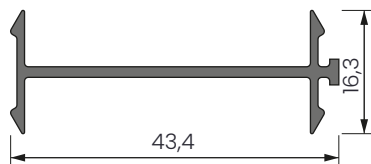

Cód. 3213

Perfil de acople.
0,29 Kg/m - Largo 6,2 m.

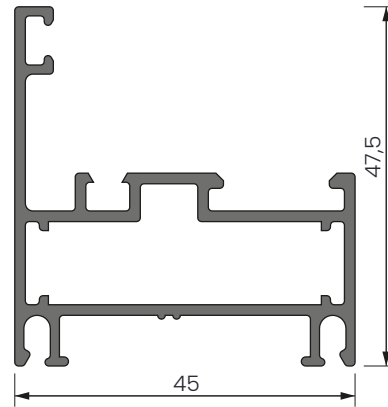

Cód. 3210

Marco de abrir con cámara compensadora.
0,838 Kg/m - Largo 6,2 m.

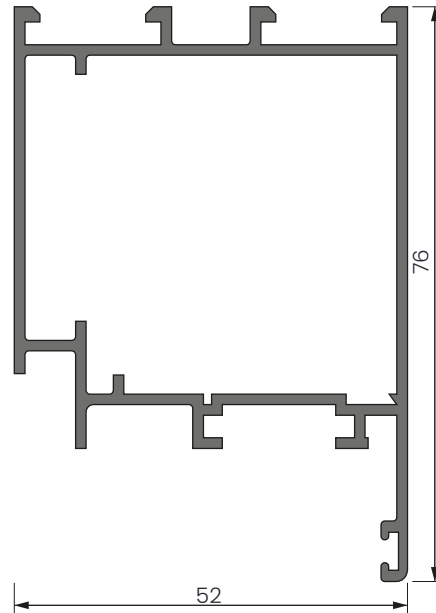

Cód. 3214

Jambas y cabezal hoja puerta de rebatir.
1,208 Kg/m - Largo 6,2 m.

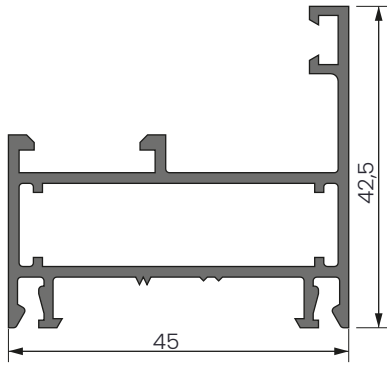

Cód. 3216

Marco de rebatir.
0,71 Kg/m - Largo 6,2 m.

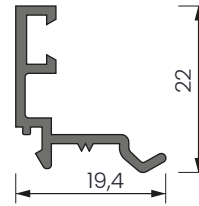

Cód. 3220

Contra vidrio exterior puerta de rebatir.
0,193 Kg/m - Largo 6,2 m.

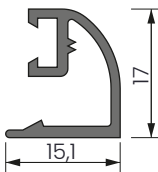

Cód. 3237

Contra vidrio puerta de rebatir.
0,139 Kg/m - Largo 6,2 m.

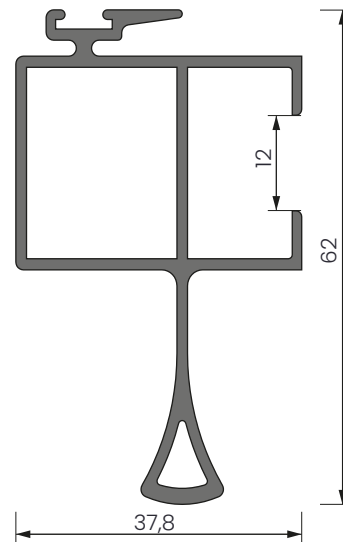

Cód. 3280

Parante central con tirador hoja VS.
0,99 Kg/m - Largo 6,2 m.

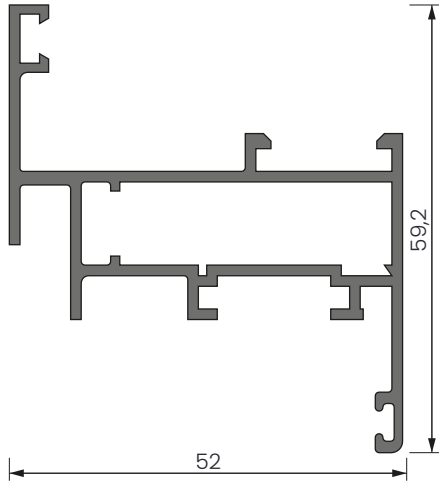

Cód. 3215

Hoja ventana de abrir doble contact banderola.
0,995 Kg/m - Largo 6,2 m.

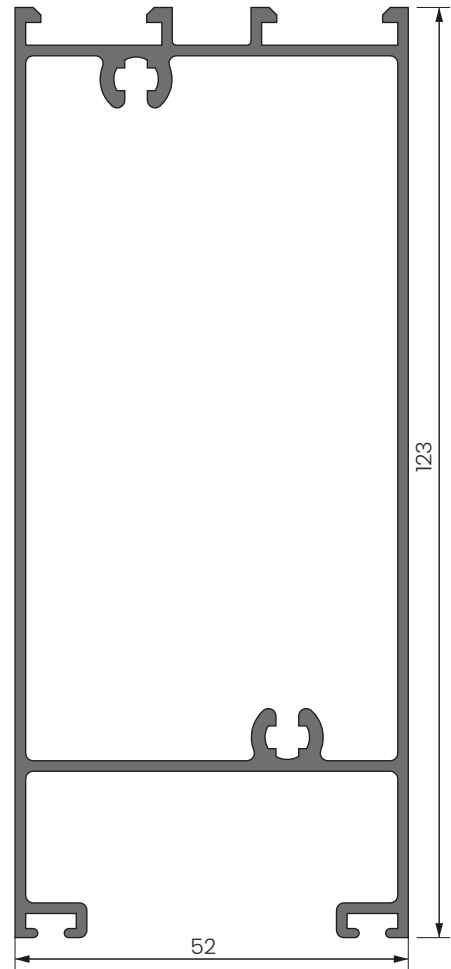

Cód. 3219

Zócalo hoja puerta de rebatir.
1,645 Kg/m - Largo 6,2 m.

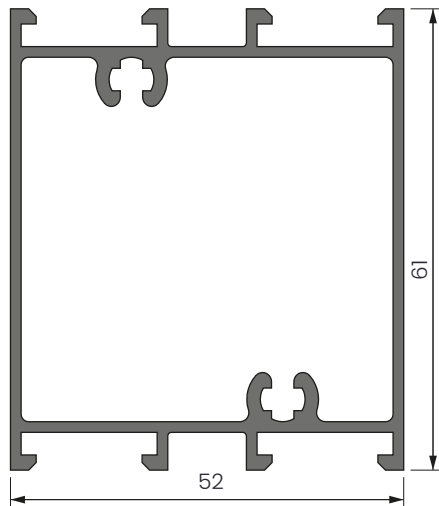

Cód. 3218

Travesaño hoja puerta de rebatir.
1,193 Kg/m - Largo 6,2 m.

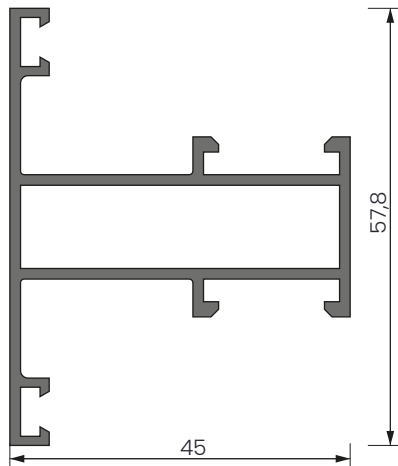

Cód. 3221

Travesaño angosto paño fijo.
0,760 Kg/m - Largo 6,2 m.

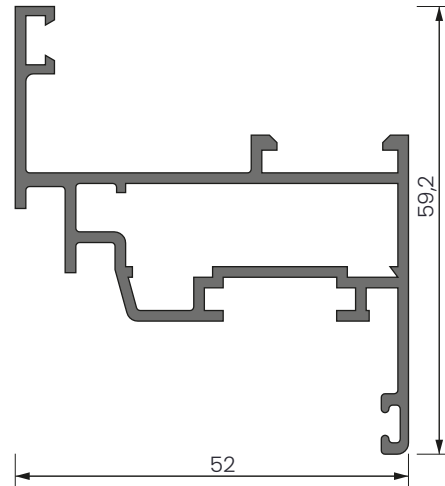

Cód. 3234

Hoja ventana de abrir
con cámara compensadora.
0,880 Kg/m - Largo 6,2 m.

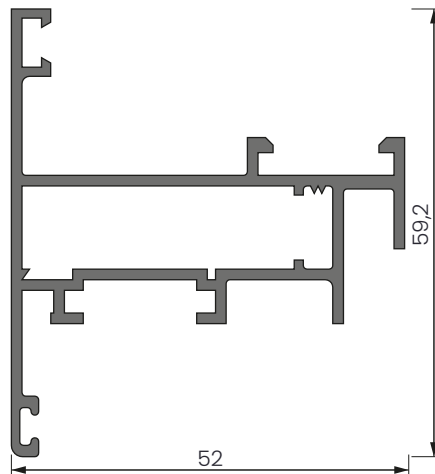

Cód. 3227

Hoja ventiluz.
0,840 Kg/m - Largo 6,2 m.

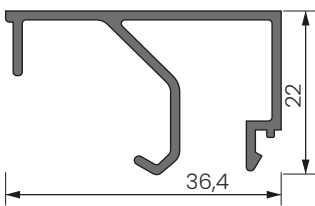

Cód. 3212

Contravidrio recto 36mm.
0,354 Kg/m - Largo 6,2 m.

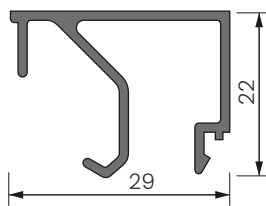

Cód. 3217

Contravidrio recto 29mm.
0,291 Kg/m - Largo 6,2 m.

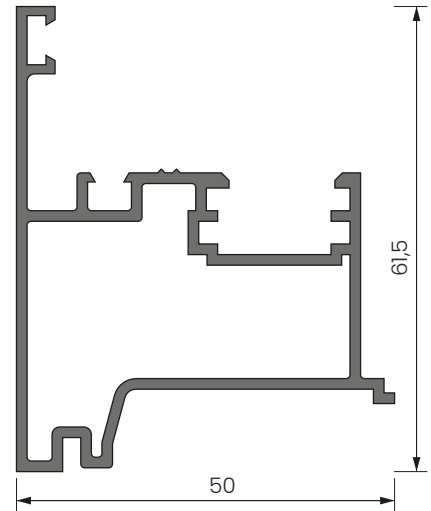

Cód. 3223

Encuentro central ventana de abrir
con cámara compensadora.
0,975 Kg/m - Largo 6,2 m.

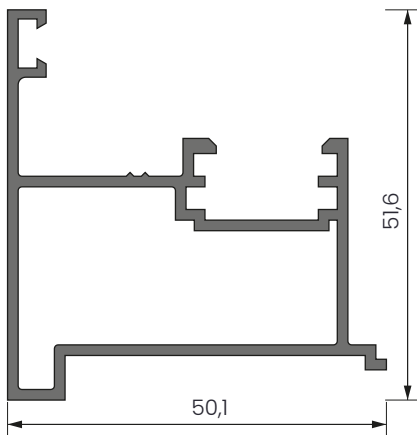

Cód. 3224

Encuentro central ventana
de abrir doble contacto.
0,806 Kg/m - Largo 6,2 m.

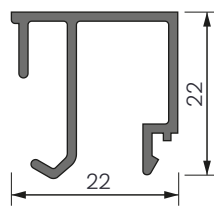

Cód. 3225

Contravidrio recto de 22mm.
0,258 Kg/m - Largo 6,2 m.

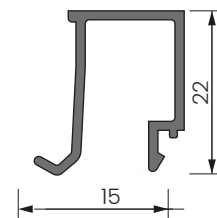

Cód. 3226

Contravidrio recto de 15mm.
0,233 Kg/m - Largo 6,2 m.

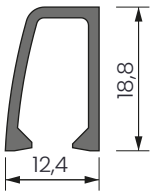

Cód. 3228

Tope mosquitero corrediza.
0,201 Kg/m - Largo 6,2 m.

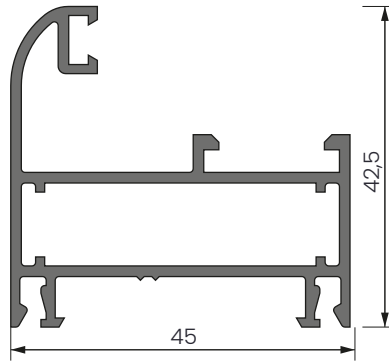

Cód. 3229

Marco paño fijo curvo.
0,741 Kg/m - Largo 6,2 m.

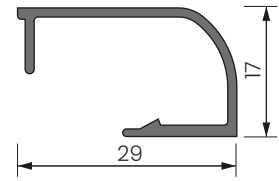

Cód. 3230

Contra vidrio curvo 29mm.
0,225 Kg/m - Largo 6,2 m.

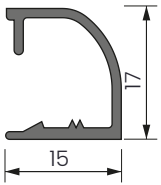

Cód. 3231

Contra vidrio curvo 15mm.
0,165 Kg/m - Largo 6,2 m.

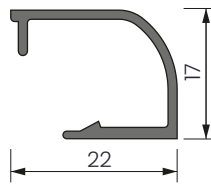

Cód. 3232

Contra vidrio curvo 22mm.
0,201 Kg/m - Largo 6,2 m.

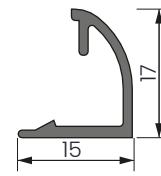

Cód. 3233

Contra vidrio curvo 8mm.
0,199 Kg/m - Largo 6,2 m.

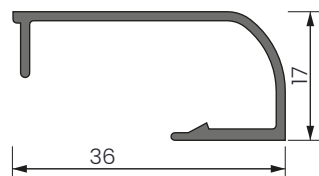

Cód. 3238

Contra vidrio curvo 36mm.
0,201 Kg/m - Largo 6,2 m.

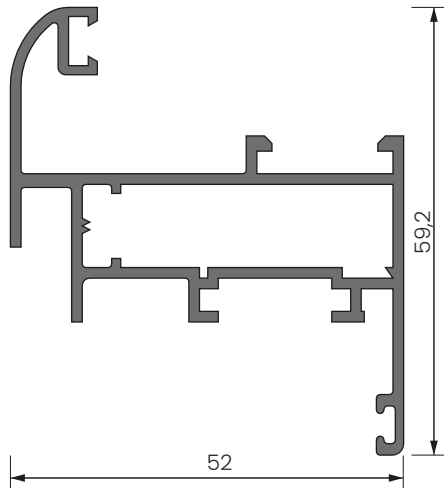

Cód. 3235

Hoja de abrir doble contacto.
0,885 Kg/m - Largo 6,2 m.

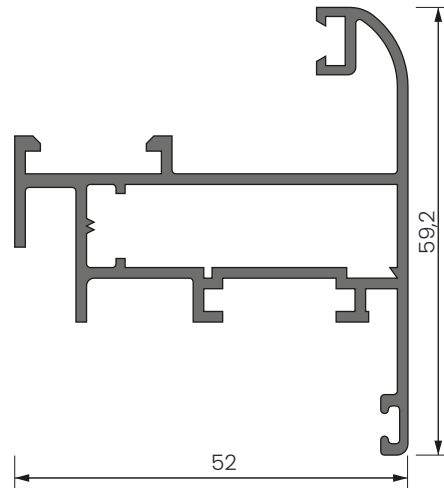

Cód. 3236

Hoja curva ventiluz.
0,897 Kg/m - Largo 6,2 m.

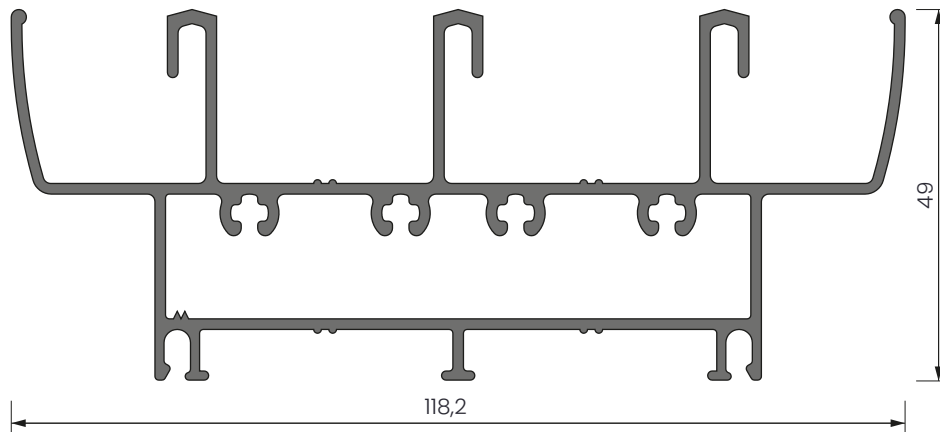

Cód. 3240

Marco de 3 guías corte 45°.
1,87 Kg/m - Largo 6,2 m.

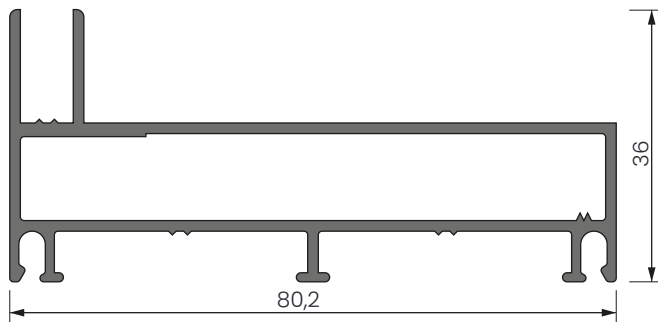

Cód. 3241

Jamba de marco de 3 guías.
0,995 Kg/m - Largo 6,2 m.

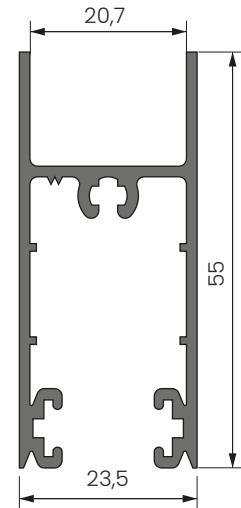

Cód. 3202

Zócalo para DVH.
0,655 Kg/m - Largo 6,2 m.

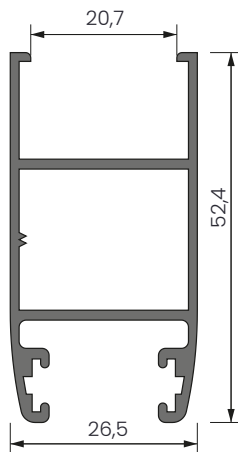

Cód. 3203

Parante lateral corrediza para DVH.
0,645 Kg/m - Largo 6,2 m.

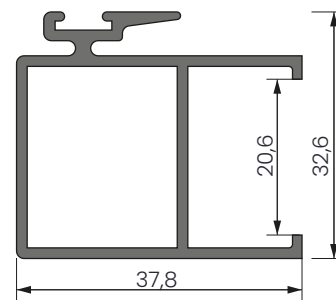

Cód. 3204

Parante central corrediza para DVH.
0,638 Kg/m - Largo 6,2 m.

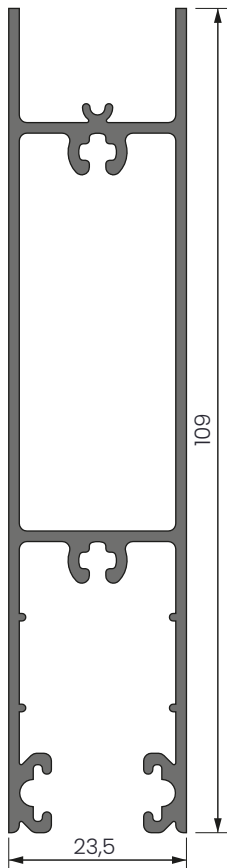

Cód. 3252

Zócalo ato corrediza
para DVH.
1,258 Kg/m - Largo 6,2 m.

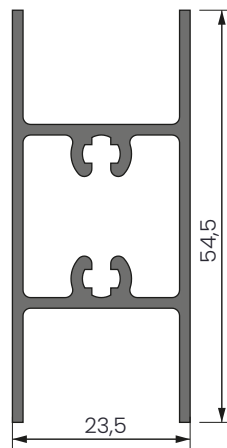

Cód. 3253

Travesaño para hoja
corredeiza DVH.
0,695 Kg/m - Largo 6,2 m.

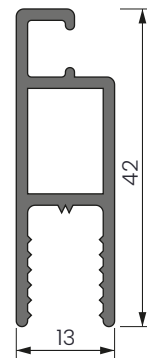

Cód. 3255

Bastidor mosquitero.
0,451 Kg/m - Largo 6,2 m.

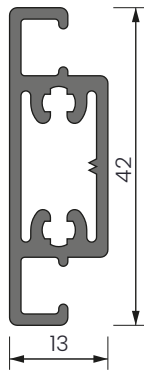

Cód. 3256

Travesaño mosquitero.
0,548 Kg/m - Largo 6,2 m.

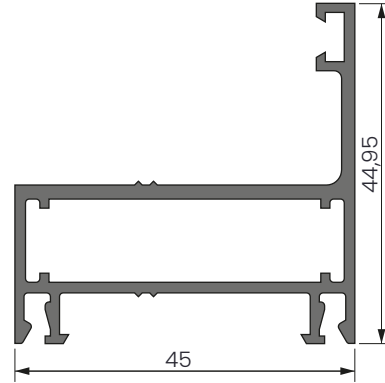

Cód. 3259

Marco de ventana proyectante recta.
0,741 Kg/m - Largo 6,2 m.

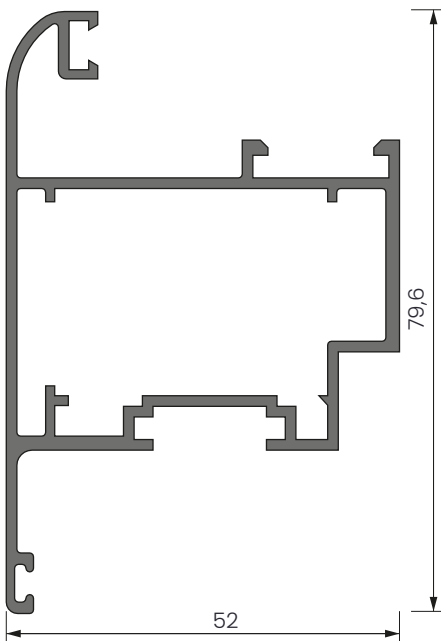

Cód. 3260

Hoja de ventana proyectante curva.
1,161 Kg/m - Largo 6,2 m.

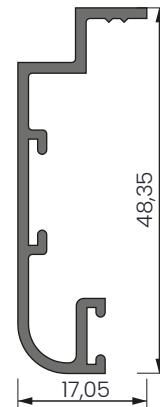

Cód. 4118

Tapa premarco.
0,345 Kg/m - Largo 6,2 m.

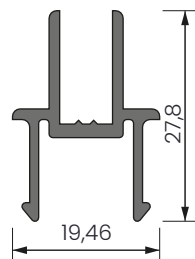

Cód. 3246

Encuentro central de 4 hojas
V y P corrediza.
0,322 Kg/m - Largo 6,2 m.

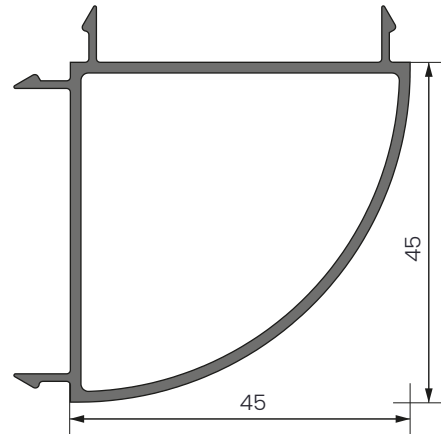

Cód. 3262

Acople a 90°.
0,685 Kg/m - Largo 6,2 m.

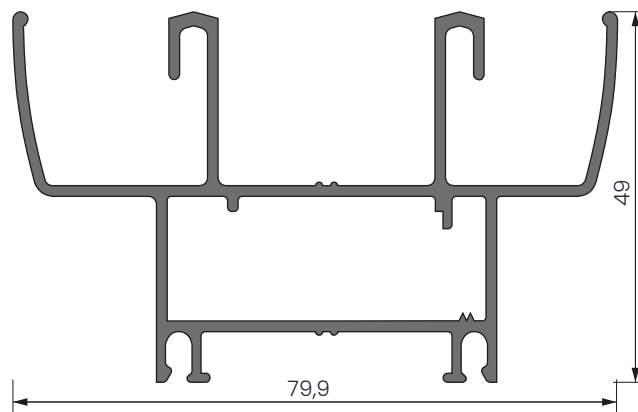

Cód. 3906

Marco preperimetral corrediza 45°.
1,185 Kg/m - Largo 6,2 m.

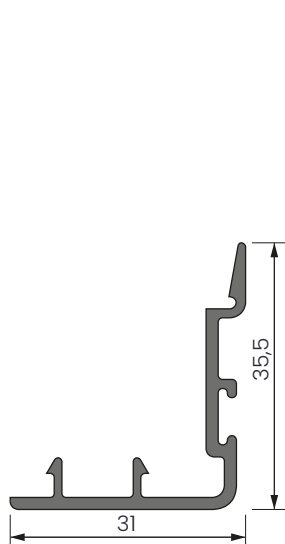

Cód. 3907

Complemento parante central corrediza 45°.
 0,345 Kg/m - Largo 6,2 m.

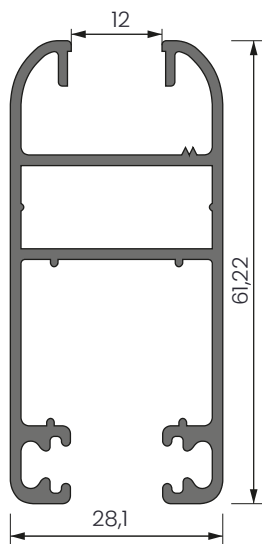

Cód. 3908

Hoja de vidrio simple corrediza 45°.
 0,875 Kg/m - Largo 6,2 m.

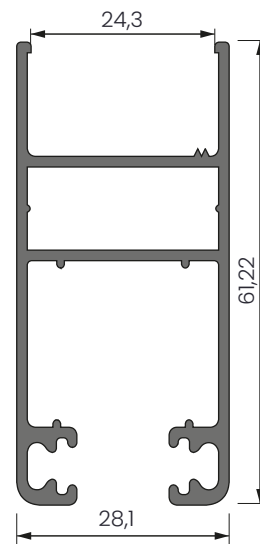

Cód. 3909

Hoja DVH corrediza 45°.
 0,820 Kg/m - Largo 6,2 m.

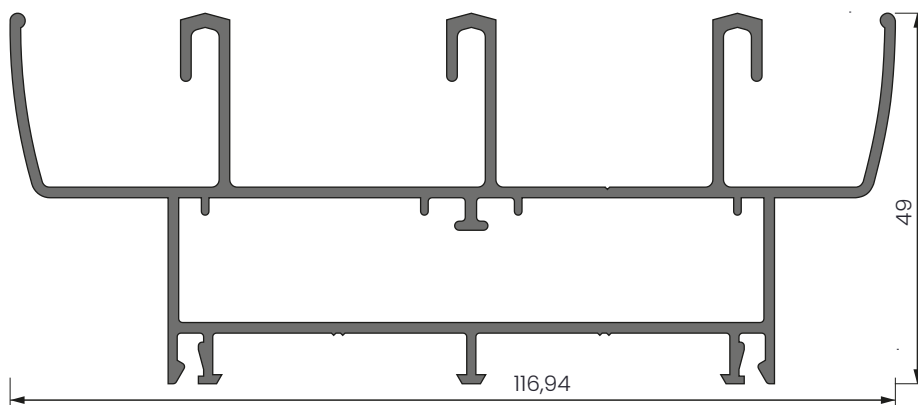

Cód. 6910

Guía triple corrediza 45°.
 1,625 Kg/m - Largo 6,2 m.

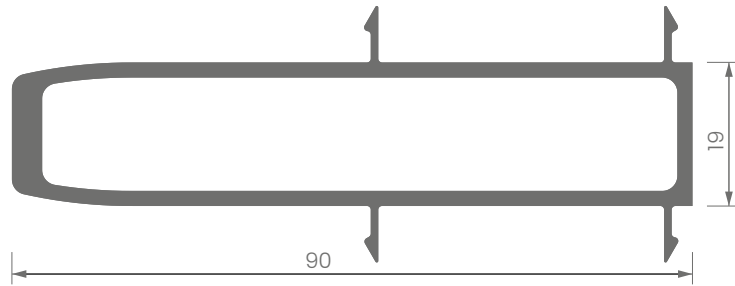

Cód. 3261

Columna de acople reforzado.
1,305 Kg/m - Largo 6,2 m.

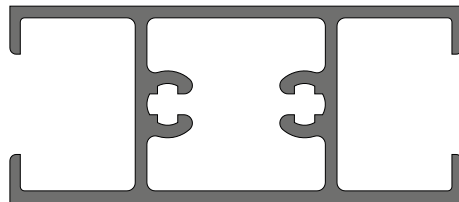

Cód. 3239

Travesaño para hoja corrediza vidrio simple.
0,755 Kg/m - Largo 6,2 m.

**No está en escala ni posee cotas.*

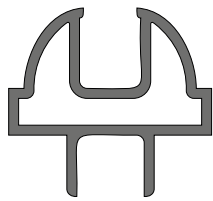

Cód. 3267

Trav. vidrio repartido para
ventana y puerta corrediza.
0,409 Kg/m - Largo 6m.

**No posee cotas.*

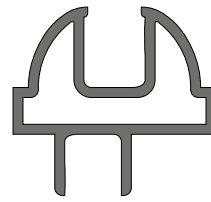

Cód. 3268

Trav. vidrio repartido para
ventana y puerta corrediza.
0,409 Kg/m - Largo 6m.

**No posee cotas.*

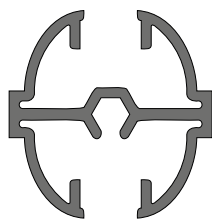

Cód. 3266

Marco vidrio repartido para
ventana y paño fijo.
0,315 Kg/m - Largo 6m.

**No posee cotas.*

Complementos

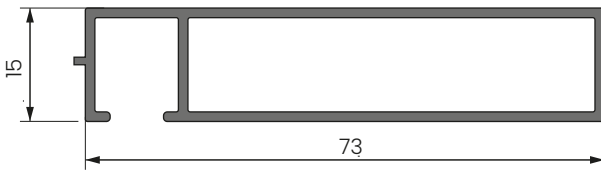

Cód. 3901

Premarco 73mm.
0,710 Kg/m - Largo 6,2m.

**No posee escala.*

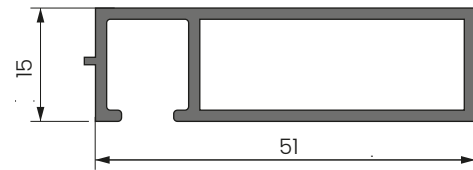

Cód. 3912

Premarco 51mm.
0,546 Kg/m - Largo 6,2m.

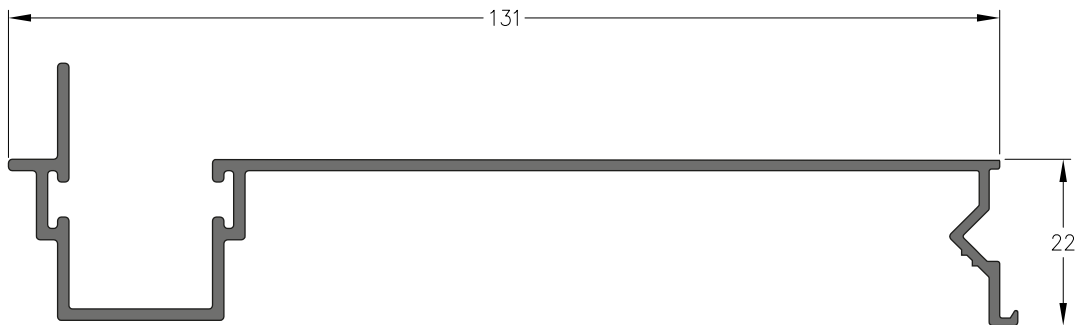

Cód. 3244

Guía de cortina.
0,766 Kg/m - Largo 6,2 m.

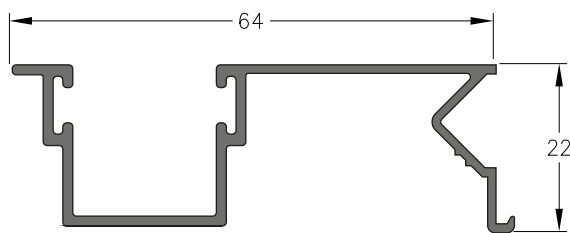

Cód. 3243

Guía de cortina común.
0,615 Kg/m - Largo 6m.

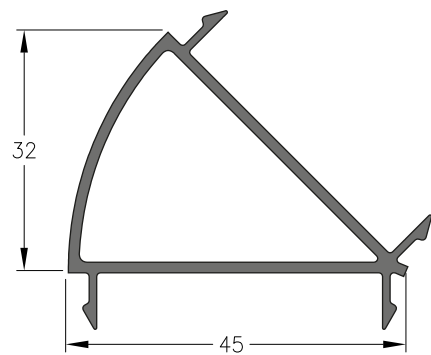

Cód. 3263

Columna 45° MD.
0,615 Kg/m - Largo 6m.

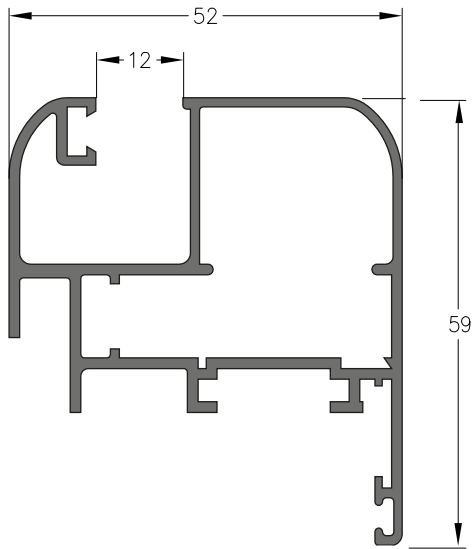

Cód. 2235

Hoja ventana abrir vidrio simple.
1,045 Kg/m - Largo 6,2 m.

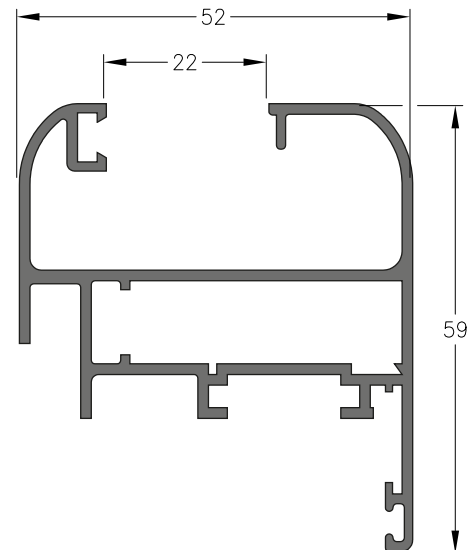

Cód. 2236

Hoja ventana abrir DVH.
1,015 Kg/m - Largo 6,2 m.

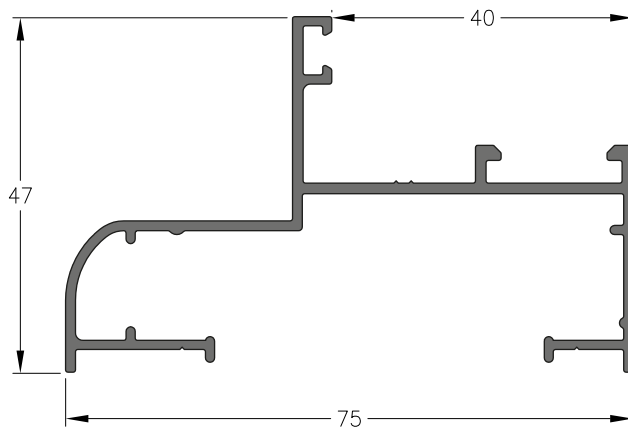

Cód. 2216

Marco venta de abrir /
Banderola / Puerta / Paño fijo..
0,741 Kg/m - Largo 6,2 m.

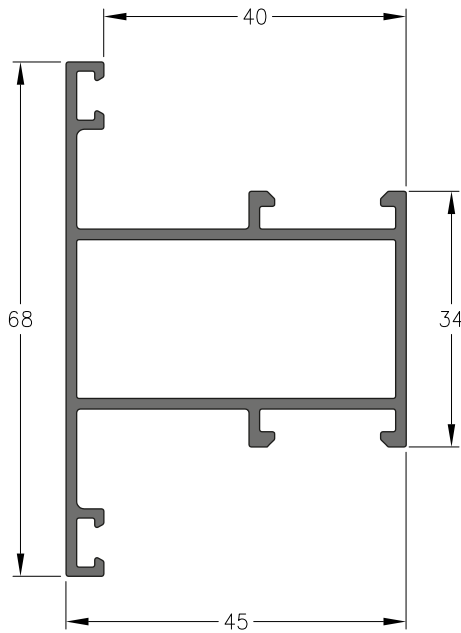

Cód. 3222

Travesaño angosto modena.
0,819 Kg/m - Largo 6,2 m.

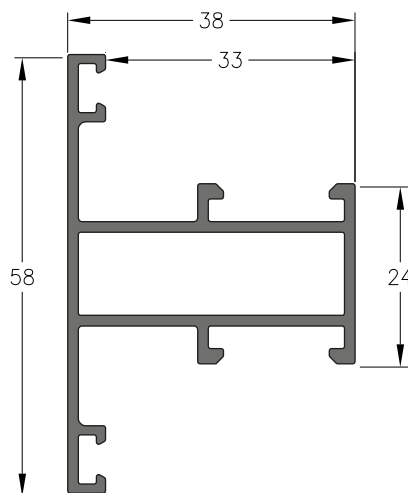

Cód. 6257

Travesaño curvo.
0,806 Kg/m - Largo 6,2 m.

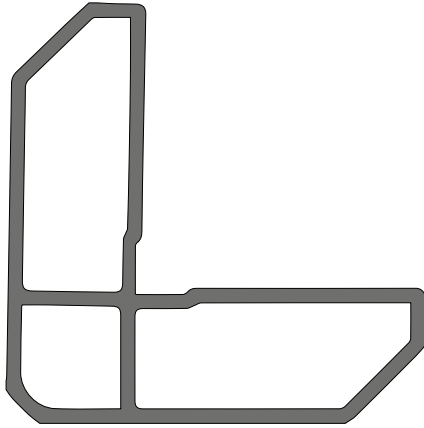

Cód. 3067

Escuadra suplementaria
puerta de rebatir.
1,050 Kg/m - Largo 6m.

**No posee cotas.*

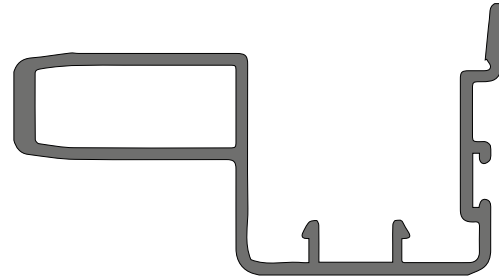

Cód. 3905

Complemento parante central
con tirador.
0,677 Kg/m - Largo 6m.

**No posee cotas.*

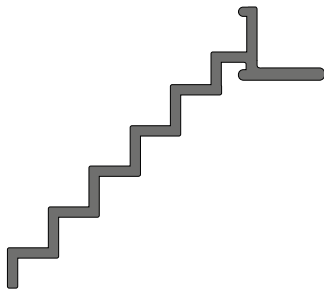

Cód. 3449

Grapa de amure para
premarco.
0,250 Kg/m - Largo 6m.

**No posee cotas.*

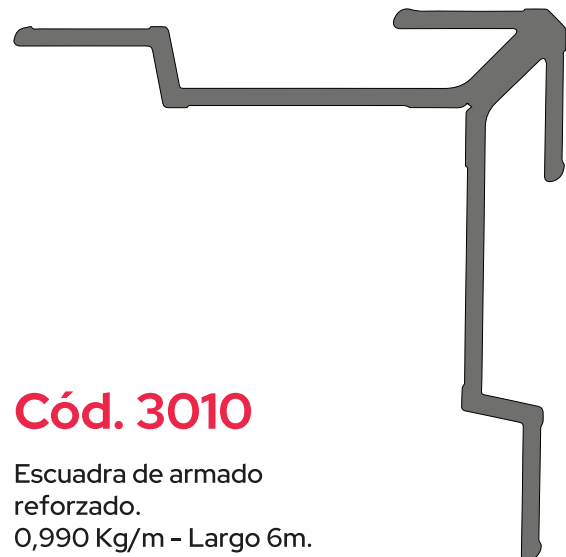

Cód. 3010

Escuadra de armado
reforzado.
0,990 Kg/m - Largo 6m.

**No posee cotas.*

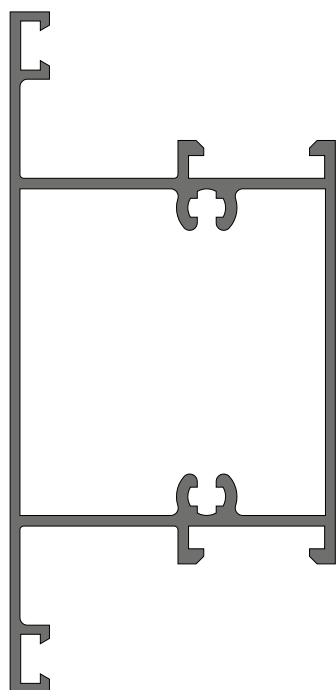

Cód. 2274

Travesaño de puerta de 50mm.
1,080 Kg/m - Largo 6,2m.

**No posee escala ni cotas.*

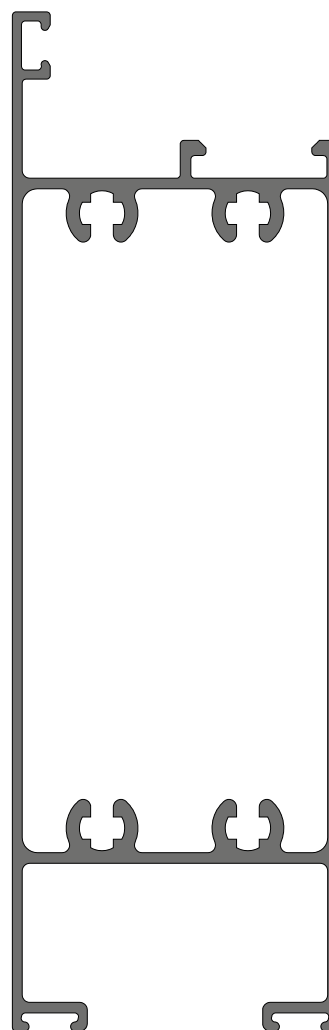

Cód. 2275

Zócalo de puerta de 50mm.
1,716 Kg/m - Largo 6,2m.

**No posee escala ni cotas.*

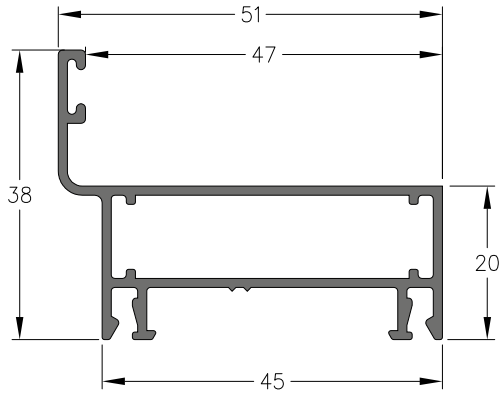

Cód. 3264

Marco puerta placa.
0,596 Kg/m - Largo 6,2m.

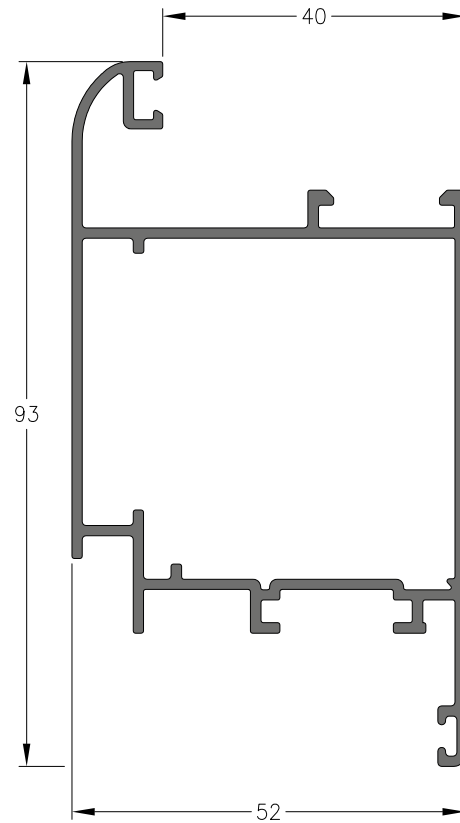

Cód. 2273

Parante puerta de rebatir
con contravidrio curvo.
1,15 Kg/m - Largo 6,2m.



📍 Ruta 34 Km 224 - Lote 81A Parque Industrial / Rafaela Santa Fe

📞 03492-506001 🌐 www.bicacolor.com.ar

📷 @bica.color